

Tous droits strictement réservés. Reproduction ou communication a des tiers interdite sous quelque forme que ce soit sans autorisation écrite du propriétaire. Propriete de c FCI. Droits de reproduction FCI.

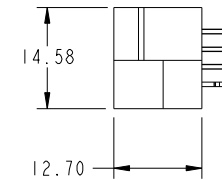

All rights strictly reserved. Reproduction or issue to third parties in any form whatever is not permitted without written authority from the proprietor. Property of FCI. Copyright FCI.

PRODUCT NO. 51963-002... NOTE 3	ROWS D C B A	SIGNAL						POWER						E2
		E1	1	2	3	4	5	6	P1	P2	P3	P4	P5	

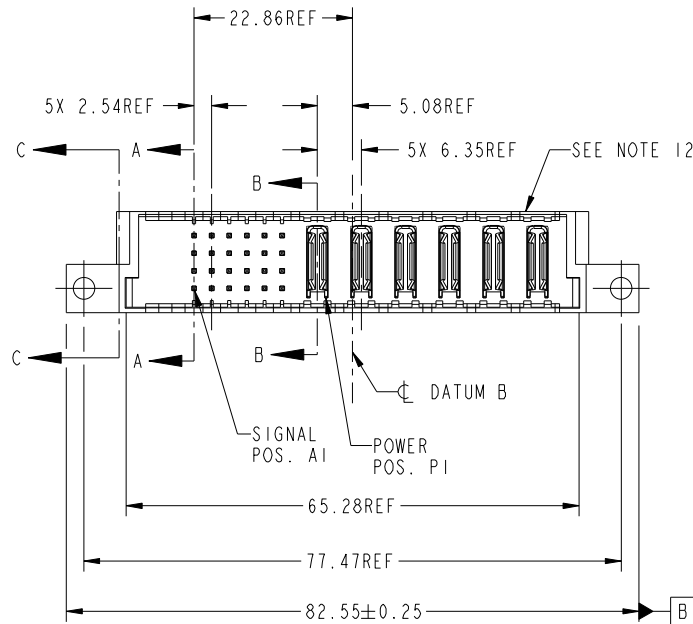

CODE	DIM "M" MATING LENGTH	CONTACT TYPE
E	6.86	SIGNAL
PA	N/A	POWER
HA	N/A	HOLD-DOWN

mat'l code				SEE NOTE 2		tolerances unless otherwise specified		CUSTOMER	
ltr	ecn no.	dr	date	linear	.XX±.01/0.X±0.3	angles	0°±2°	COPY	
A	DG07-0327	SH	08/14/07		.XXX±.005/0.XX±0.13			projection	
					.XXX±.0020/0.XXX±0.051			title	
								24S+6P	
								VERTICAL SOLDER HEADER	
								product family	
								PwrBlade	
								code	
								213	
								size	
								dwg no	
								51963-002	
								sheet	
								1 of 4	
sheet index	revision sheet	A	A	A	A				
		1	2	3	4				

CONFIDENTIAL

FCI www.fciconnect.com

scale 1:1

cage code 22526

Pro/E

Tous droits strictement reserves. Reproduction ou communication a des tiers interdite sous quelque forme que ce soit sans autorisation écrite du propriétaire. Propriete de c FCI. Droits de reproduction FCI.

All rights strictly reserved. Reproduction or issue to third parties in any form whatever is not permitted without written authority from the proprietor. Property of FCI. Copyright FCI.



PRODUCT NUMBER
51963-002--
NOTE 3

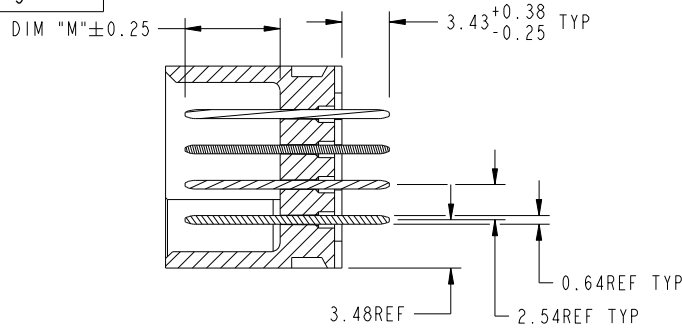

SECTION A-A
SCALE 2:1

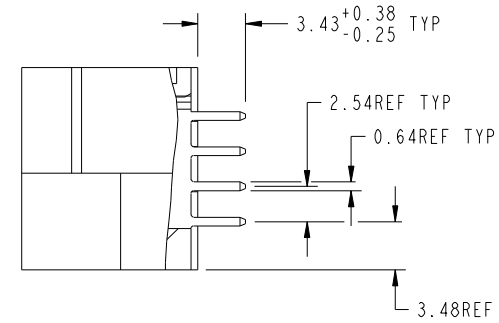

SECTION B-B
SCALE 2:1

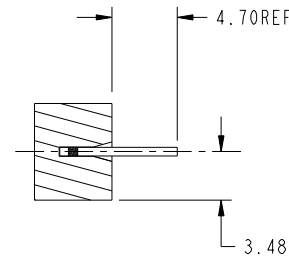
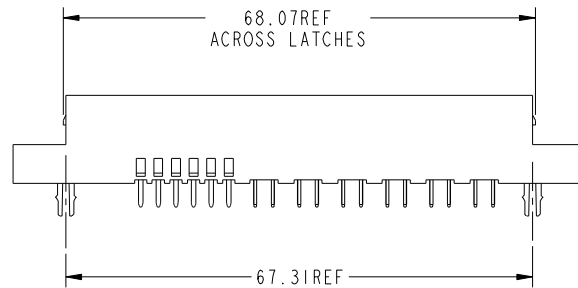

SECTION C-C
SCALE 2:1

CONFIDENTIAL

mat'l code				SEE NOTE 2		tolerances unless otherwise specified		CUSTOMER		FCI		www.fciconnect.com	
ltr	ecn no.	dr	date	linear	.XX±.01/0.X±0.3	projection	1	COPY		title			
A				angles	.XXX±.005/0.XX±0.13			24S + 6P		VERTICAL SOLDER HEADER			
				dr	.XXX±.0020/0.XXX±0.051			product family		PwrBlade	code		
				enrg	0° ± 2°	scale		size		A	213		
				chr	T. BRUNGARD 07/23/03	1:1		dwg no		51963-002			
				appd	M. MOSTOLLER 07/23/03			sheet		2 of 4			
sheet index		revision sheet											

cage code 22526

Pro/E

Tous droits strictement reserves. Reproduction ou communication a des tiers interdite sous quelque forme que ce soit sans autorisation écrite du propriétaire. Propriete de c FCI. Droits de reproduction FCI.



All rights strictly reserved. Reproduction or issue to third parties in any form whatever is not permitted without written authority from the proprietor. Property of FCI. Copyright FCI.

PRODUCT NUMBER
51963-002--
NOTE 3

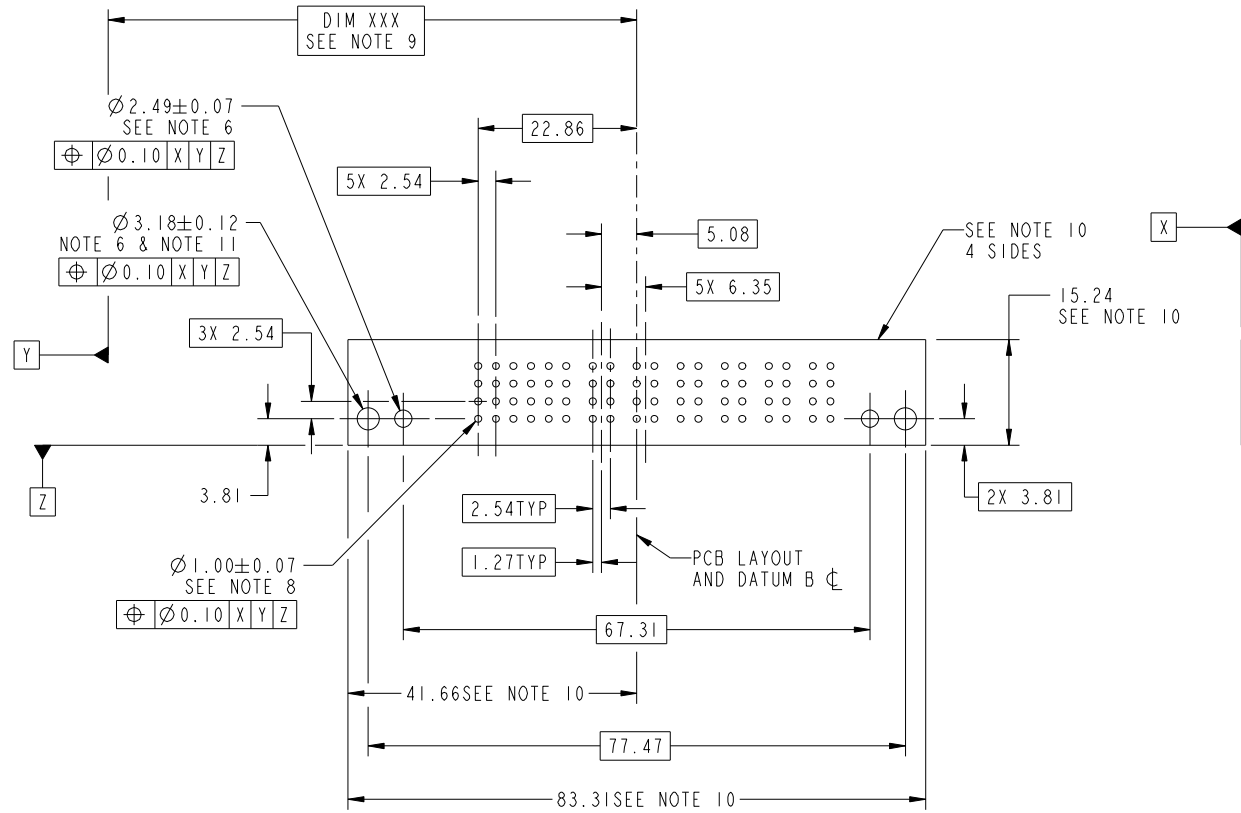

RECOMMENDED PCB LAYOUT

CONFIDENTIAL

mat'l code SEE NOTE 2				tolerances unless otherwise specified		CUSTOMER		FCI www.fciconnect.com	
ltr	ecn no.	dr	date	linear	.XX±.01/0.X±0.3	COPY		title 24S + 6P	
A					.XXX±.005/0.XX±0.13	projection		VERTICAL SOLDER HEADER	
				angles	.XXX±.0020/0.XXX±0.051			product family PwrBlade	
				dr	T. BRUNGARD 07/23/03	MIM		size	code 213
				enr	M. MOSTOLLER 07/23/03	scale		dwg no	sheet
				chr	M. MOSTOLLER 07/23/03	1:1		A	3 of 4
				appd	M. MOSTOLLER 07/23/03			51963-002	
sheet index	revision sheet								

cage code
22526

Pro/E

Tous droits strictement reserves. Reproduction ou communication a des tiers interdite sous quelque forme que ce soit sans autorisation écrite du propriétaire. Propriete de c FCI. Droits de reproduction FCI.



All rights strictly reserved. Reproduction or issue to third parties in any form whatever is not permitted without written authority from the proprietor. Property of FCI. Copyright FCI.

PRODUCT NUMBER
51963-002--
NOTE 3

NOTES:

1. DIMENSIONS AND TOLERANCES ARE IN ACCORDANCE WITH ASME Y14.5M, 1994 UNLESS OTHERWISE SPECIFIED.

CONNECTOR NOTES:

2 HOUSING MATERIAL: UL 94 V-0 GLASS FILLED

HIGH-TEMP THERMOPLASTIC
POWER CONTACT MATERIAL: COPPER ALLOY
SIGNAL PIN MATERIAL: COPPER ALLOY

3. PLATING:

51963-002 SIGNAL PINS: 30u"/0.76um Au OVER 50u"/1.27um Ni ON THE CONTACT AREA
AND 100u"/2.54um SnPb PLATING OVER 50u"/1.27um Ni ON THE TERMINATION SECTION
POWER PINS: 30u"/0.76um Au OVER 50u"/1.27um Ni ON THE CONTACT AREA
AND 100u"/2.54um SnPb PLATING OVER 50u"/1.27um Ni ON THE TERMINATION SECTION
51963-002LF SIGNAL PINS: 30u"/0.76um Au OVER 50u"/1.27um Ni ON THE CONTACT AREA
AND 78u"/2.00um Sn PLATING OVER 50u"/1.27um Ni ON THE TERMINATION SECTION
POWER PINS: 30u"/0.76um Au OVER 50u"/1.27um Ni ON THE CONTACT AREA
AND 78u"/2.00um Sn PLATING OVER 50u"/1.27um Ni ON THE TERMINATION SECTION

PART NUMBER 51963-002LF MEETS EUROPEAN UNION DIRECTIVE AND OTHER COUNTRY REGULATIONS AS DESCRIBED IN GS-22-008
THE HOUSING WILL WITHSTAND EXPOSURE TO 260° PEAK TEMPERATURE FOR 10 SECONDS IN A WAVE SOLDER APPLICATION WITH A CIRCUIT BOARD.

4. PRODUCT SPECIFICATION GS-12-149.
APPLICATION SPECIFICATION BUS-20-067.

5. PACKAGED IN TRAYS.

PCB NOTES:

6. ALL HOLE DIAMETERS ARE FINISHED HOLE SIZE.
7. MOUNTING HOLES, WHERE APPLICABLE, ARE UNPLATED.

8 $\varnothing .0453 \pm .0010$ [1.151 ± 0.025] DRILLED HOLES PLATED WITH
.0003 [0.008] MIN SnPb OR Sn OVER .001 [0.03]
TO .003 [0.08] Cu PLATING TO ACHIEVE
 $\varnothing .040 \pm .003$ [1.02 ± .07] HOLE.

9 "DIM XXX" TO BE DETERMINED BY THE CUSTOMER.

10 CONNECTOR KEEP-OUT ZONE.

11 CUSTOMER SUPPLIES (2) #4-40 UNC SCREWS,
HARDWARE TO MOUNT HEADER TO PC BOARD.
12 MANUFACTURER'S NAME, P/N, AND DATE CODE TO
APPEAR ON THIS SURFACE.

CONFIDENTIAL

mat'l code				SEE NOTE 2		tolerances unless otherwise specified		CUSTOMER		FCI		www.fciconnect.com	
ltr	ecr no.	dr	date	linear	.XX±.01/0.X±0.3	projection	1	COPY		title		24S + 6P	
A				angles	.XXX±.005/0.XX±0.13					VERTICAL SOLDER HEADER			
				dr	.XXX±.0020/0.XXX±0.051			product family		PwrBlade	code	213	
				engr	0° ± 2°	scale		size	dwg no	51963-002		sheet	4 of 4
				chr	T. BRUNGARD 07/23/03	1:1		A					
				appd	M. MOSTOLLER 07/23/03								
sheet index		revision sheet											

cage code 22526

Pro/E