



1000 ~ 3000W 1U Distributed Power System

RCP-1U Rack System



Rack Dimension

L	*	W	*	H
483.6	*	350.8	*	44 (1U) mm
19	*	13.8	*	1.73(1U) inch



■ Features

- Universal AC input / Full range
- 1U profile 19" rack shelf, fitting three 1000W modules up to 3000W with active current sharing
- Output voltage programmable
- Support hot swap (hot plug)
- 5 years warranty

■ Applications

- Industrial automation
- Distributed power architecture system
- Wireless/telecommunication solution
- Redundant power system
- Electric vehicle charger system
- Constant current source system

■ Description

RCP-1U rack system is a power distribution solution utilizing the rack configuration with 1U low profile. Starting with a single unit of 1000W, RCP-1000 is the front end rectifier (or, power supply). With the active current sharing function, up to 3000W is able to be provided by 1 stack of the 19" rack mountable shelf RCP-1U and 8000W by 3 stacks. The design flexibility for system applications is ideally fulfilled by various built-in features, such as output programming, remote ON-OFF, auxiliary power, etc.

■ Model Encoding / Order Information

Rack Shelf:

RCP-1U I

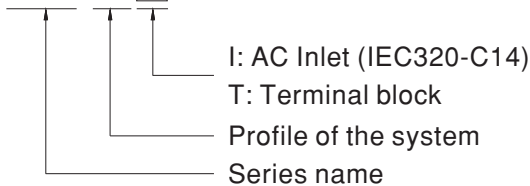

Whole System:

RCP-3K1U I-12-C

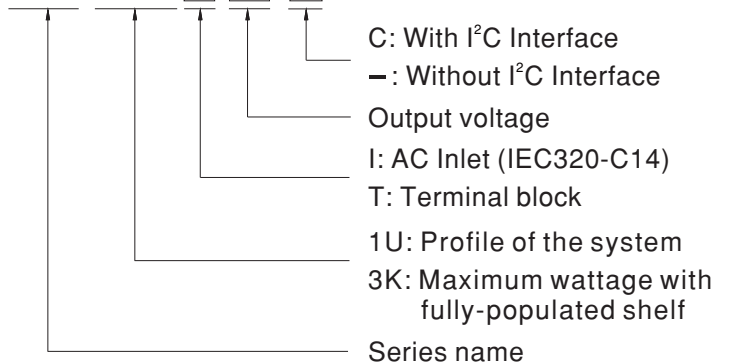



1000 ~ 3000W 1U Distributed Power System **RCP-1U Rack System**

SPECIFICATION - Power Supply System

MODEL		RCP-3K1U□-12	RCP-3K1U□-24	RCP-3K1U□-48	
OUTPUT	RECTIFIER	RCP-1000-12	RCP-1000-24	RCP-1000-48	
	RACK SHELF	RCP-1UI or RCP-1UT			
	OUTPUT VOLTAGE	12V	24V	48V	
	MAX. OUTPUT CURRENT	180A	120A	63A	
	MAX. OUTPUT POWER <small>Note.6</small>	2160W	2880W	3024W	
INPUT	VOLTAGE RANGE <small>Note.5</small>	90 ~ 264VAC 127 ~ 370VDC			
	FREQUENCY RANGE	47 ~ 63Hz			
	AC CURRENT (Typ.)/PER MODULE	8.5A/115VAC 4.5A/230VAC	10.5A/115VAC 5.5A/230VAC	11A/115VAC 5.5A/230VAC	
	LEAKAGE CURRENT	<3.5mA / 230VAC			
FUNCTION	AUXILIARY POWER	5V @ 0.3A			
	REMOTE ON-OFF CONTROL	By electrical signal or dry contact ON:short OFF:open			
	REMOTE SENSE	Compensate voltage drop on the load wiring up to 0.5V.			
	OUTPUT VOLTAGE PROGRAMMABLE	Adjustment of output voltage is allowable to 90 ~ 110% of nominal output voltage. Please refer to the Function Manual.			
	DC OK SIGNAL	The isolated TTL signal out, Please refer to the Installation Manual			
	AC OK SIGNAL	The isolated TTL signal out, Please refer to the Installation Manual			
	OVER TEMP WARNING	Logic " High" for over temperature warning, Please refer to the Installation Manual, isolated signal			
ENVIRONMENT	WORKING TEMP.	-20 ~ +60°C (Refer to "Derating Curve")			
	WORKING HUMIDITY	20 ~ 90% RH non-condensing			
	STORAGE TEMP., HUMIDITY	-40 ~ +85°C, 10 ~ 95% RH			
	TEMP. COEFFICIENT	±0.02%/°C (0 ~ 50°C)			
	VIBRATION	10 ~ 500Hz, 2G 10min./1cycle, 60min. each along X, Y, Z axes			
SAFETY & EMC (Note 4)	SAFETY STANDARDS	UL60950-1, TUV EN60950-1 approved			
	WITHSTAND VOLTAGE	I/P-O/P:3KVAC I/P-FG:2KVAC O/P-FG:0.7KVDC			
	ISOLATION RESISTANCE	I/P-O/P, I/P-FG, O/P-FG:100M Ohms / 500VDC / 25°C / 70% RH			
	EMC EMISSION	Parameter	Standard	Test Level / Note	
		Conducted	EN55022 (CISPR22) / EN55011 (CISPR11)	Class B	
		Radiated	EN55022 (CISPR22) / EN55011 (CISPR11)	Class B	
		Harmonic Current	EN61000-3-2	-----	
	Voltage Flicker	EN61000-3-3	-----		
	EMC IMMUNITY	EN55024 , EN61204-3, EN61000-6-2			
		Parameter	Standard	Test Level / Note	
		ESD	EN61000-4-2	Level 3, 8KV air ; Level 2, 4KV contact	
		Radiated	EN61000-4-3	Level 3	
		EFT / Burst	EN61000-4-4	Level 3	
		Surge	EN61000-4-5	Level 4, 4KV/Line-Earth ; Level 3, 2KV/Line-Line	
Conducted		EN61000-4-6	Level 3		
Magnetic Field		EN61000-4-8	Level 4		
Voltage Dips and Interruptions	EN61000-4-11	>95% dip 0.5 periods, 30% dip 25 periods, >95% interruptions 250 periods			
OTHERS	DIMENSION	Rack 483.6*350.8*44(L*W*H)			
	PACKING	13.2Kg; 1pcs/13.2Kg/2.67CUFT			
NOTE	<p>1. All parameters NOT specially mentioned are measured at 230VAC input, rated load and 25°C of ambient temperature.</p> <p>2. Ripple & noise are measured at 20MHz of bandwidth by using a 12" twisted pair-wire terminated with a 0.1uf & 47uf parallel capacitor. Under parallel operation of more than one rack connecting together, ripple of the output voltage may be higher than the SPEC at light load condition. It will go back to normal ripple level once the output load is more than 10%. .</p> <p>3. Tolerance : includes set up tolerance, line regulation and load regulation.</p> <p>4. The power supply is considered a component which will be installed into a final equipment. All the EMC tests are been executed by mounting the unit on a 720mm*360mm metal plate with 1mm of thickness. The final equipment must be re-confirmed that it still meets EMC directives. For guidance on how to perform these EMC tests, please refer to "EMI testing of component power supplies." (as available on http://www.meanwell.com)</p> <p>5. Derating may be needed under low input voltages. Please check the derating curve for more details.</p> <p>6. Output of all the RCP-1000 modules are connected in parallel in the rack.</p>				

Function Manual

1. Remote ON/OFF Control

The PSU can be turned ON/OFF together or separately by using the "Remote ON-OFF" function.

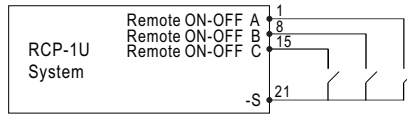
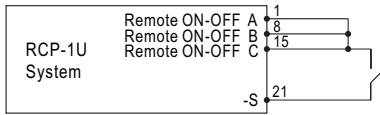

Between Remote ON-OFF and -S	Output
Switch Open	OFF
Switch Short	ON

2. Voltage Drop Compensation

2.1 Remote Sense

The remote sense compensates voltage drop on the load wiring up to 0.5V.

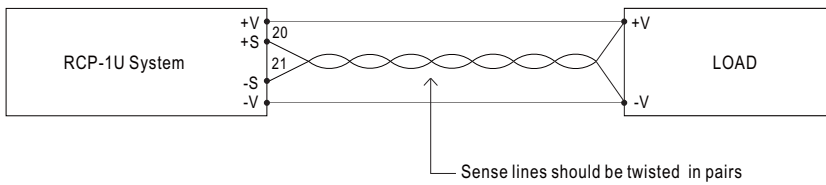

2.2 Local Sense

Notice : The +S,-S, on CN500 have to be connected to the +V,-V terminals locally in order to get the correct output voltage if the remote sensing is not used.

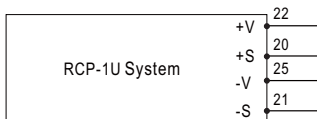

3. Output Voltage Programming (or, PV / remote voltage programming / remote adjust / margin programming / dynamic voltage trim)

(1) Output voltage can be trimmed between 90~110% of its rated value by the following method.

(2) +S & +V, -S & -V also need to be connected on CN500.

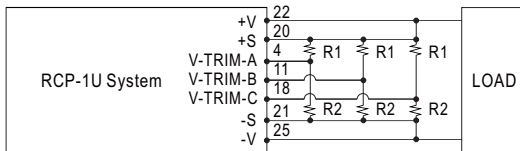

3.1 RCP-1000-12

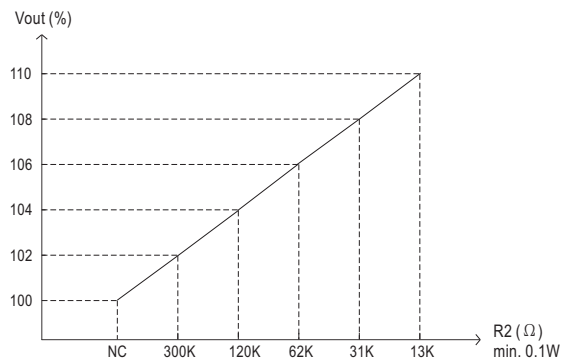
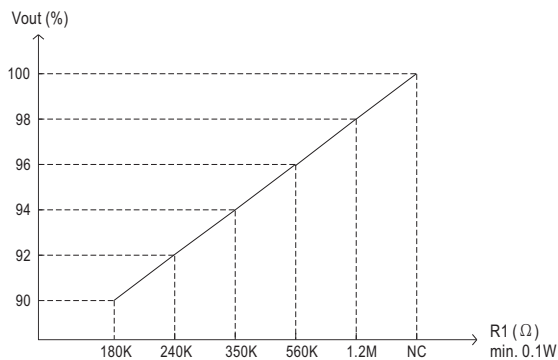

3.2 RCP-1000-24

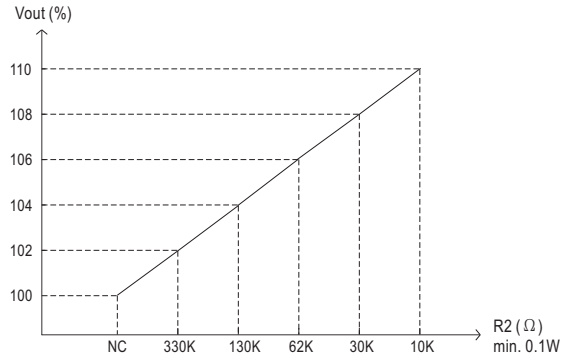
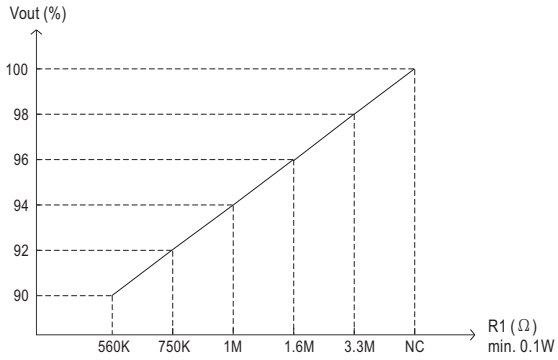

3.3 RCP-1000-48

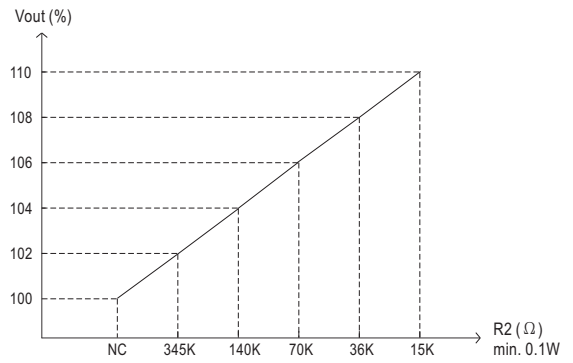
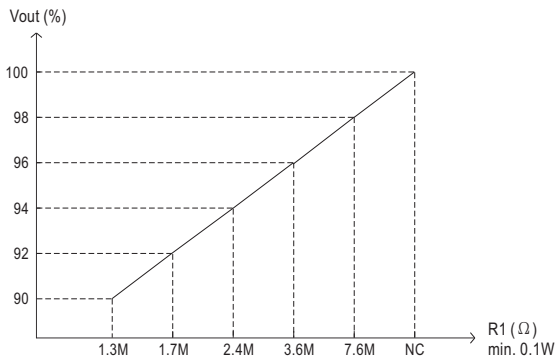

4. I²C Bus Interface Option

※ For the details of I²C option, please refer to the Installation Manual.

■ Mechanical Specification (Rack System)

Case No. 959A Unit:mm

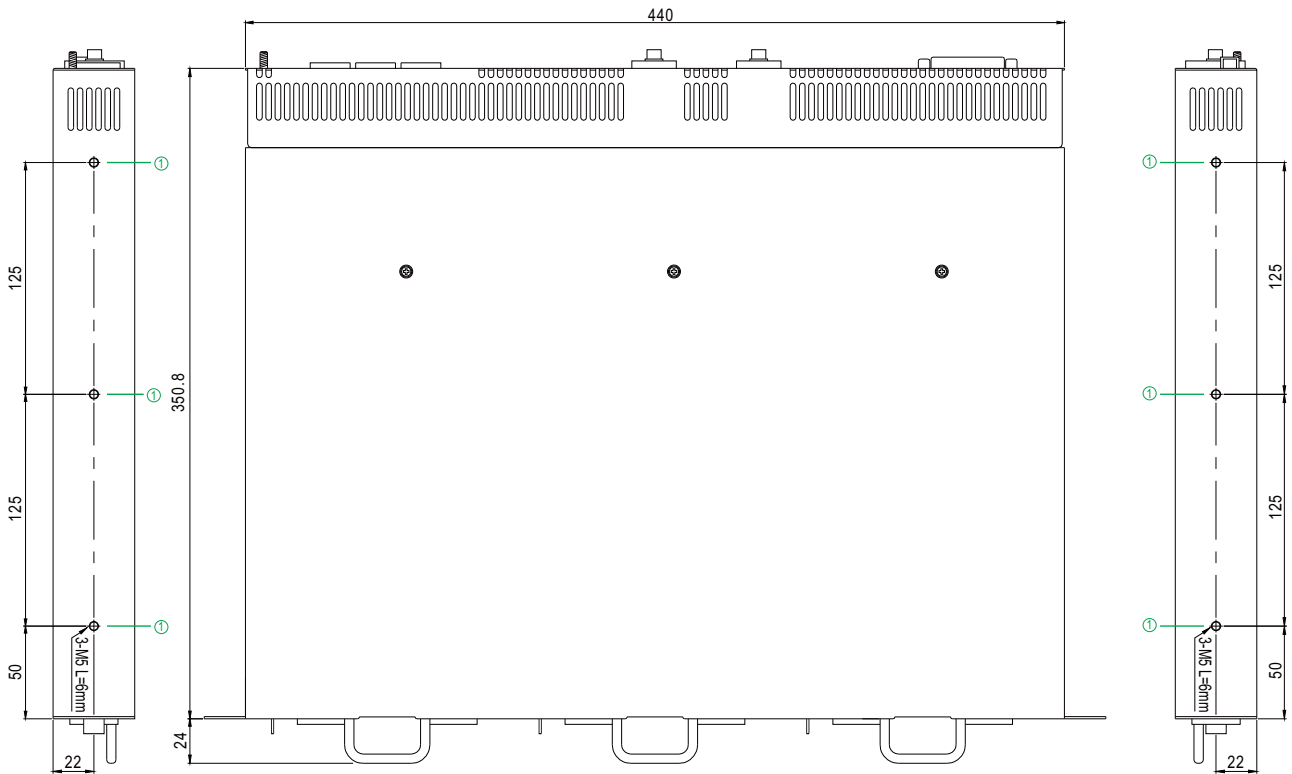
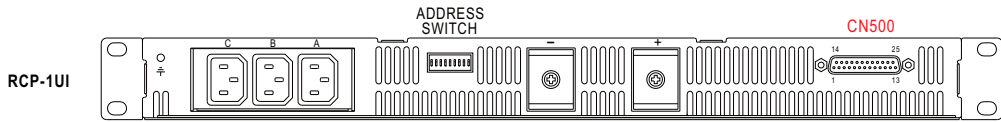
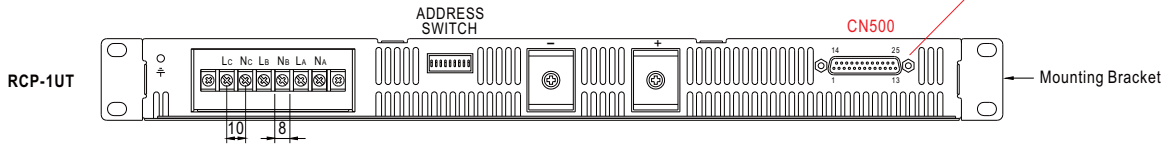
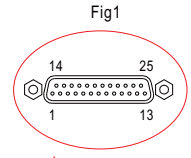
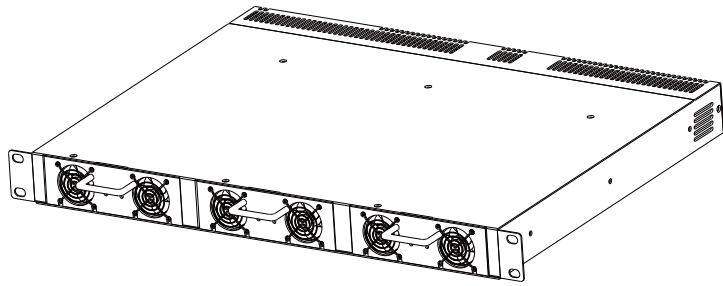

↑ Air flow direction

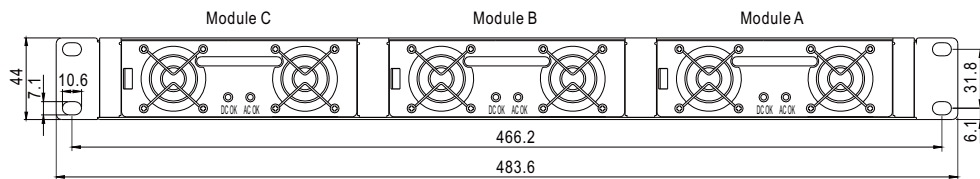

※ Mounting Instruction

Hole No.	Recommended Screw Size	MAX. Penetration Depth L	Recommended mounting torque
①	M5	6mm	10Kgf-cm

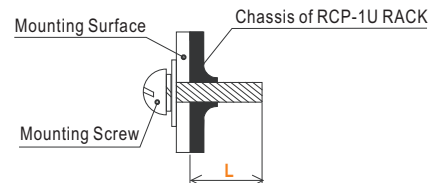

※ IN/OUT Connector Pin No. Assignment(CN500) : D-Type Right Angle 25 positions(female type)

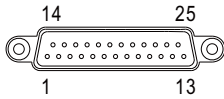

Pin No.	Function	Description
1,8,15	RemoteON-OFF	Each unit can separately turn the output on and off by electrical or dry contact between Remote ON-OFF A,B,C(pin 1,8,15) and -S(pin 21). Short: ON, Open:OFF.
2,9,16	AC-OK	Low : When input voltage is $\geq 82\text{Vrms} \pm 4\text{V}$. High : When input voltage is $\leq 82\text{Vrms} \pm 4\text{V}$.
3,10,17	DC-OK	High : When $V_{out} \leq 80\% \pm 5\%$. Low : When $V_{out} \geq 80\% \pm 5\%$
4,11,18	V-TRIM	Connection for output voltage programming.
5,12,19	T-ALARM	High : When the internal temperature is within safe limit. Low : 10°C below the thermal shut down limit.
6	+5V-AUX	Auxiliary voltage output, 4.3~5.3V, referenced to GND-AUX(pin 7). The maximum load current is 0.3A. This output has the built-in "Oring diodes" and is not controlled by the remote ON/OFF control.
7	GND-AUX	Auxiliary voltage output GND. The signal return is isolated from the output terminals (+V & -V).
14	CS	Current sharing signal. When units are connected in parallel, the CS pins of the units should be connected to allow current balance between units.
20	+S	Positive sensing for Remote Sense.
21	-S	Negative sensing for Remote Sense.
22	+V	Positive output voltage.
23	SCL	Serial clock used in the I ² C interface option. Refer to the Instruction Manual.
24	SDA	Serial data used in the I ² C interface option. Refer to the Instruction Manual.
25	-V	Negative output voltage.

■ Installation Manual

Please refer to the manual of RCP-1U system.