

Evaluation Board for [AD5683R](#), Single, 16-Bit, Serial Voltage-Output DAC

FEATURES

Full-featured evaluation board for the [AD5683R](#)
 On-board reference
 Various link options
 PC control in conjunction with Analog Devices
 System demonstration platform (SDP)
 PC software for control of DACs
 On-board ADC for voltage readback

PACKAGE CONTENTS

[AD5683R](#) evaluation board

[AD5683R](#) device

CD that includes

Self-installing software that allows users to control the board and exercise all functions of the device

Electronic version of the [AD5683R](#) data sheet

Electronic version of [EVAL-AD5683R](#) user guide

ADDITIONAL EQUIPMENT NEEDED

PC control via a separately purchased system demonstration platform (SDP-B or SDP-S)

GENERAL DESCRIPTION

The Analog Devices, Inc., [AD5683R](#) evaluation board ([EVAL-AD5683RSDZ](#)) is designed to help customers quickly prototype new [AD5683R](#) circuits and reduce design time. The [AD5683R](#) operates from a single 2.7 V to 5.5 V supply. The part incorporates an internal 2.5 V on-board reference to give an output voltage span of 2.5 V or 5 V.

The evaluation board interfaces to the USB port via the SDP board. Software is available with the evaluation board, which allows the user to easily program the [AD5683R](#).

This evaluation board requires the [EVAL-SDP-CB1Z](#) board. This is available on the Analog Devices website.

Full data on the [AD5683R](#) may be found in the [AD5683R](#) data sheet available from Analog Devices and should be consulted in conjunction with this user guide when using the evaluation board.

EVALUATION BOARD PHOTOGRAPH

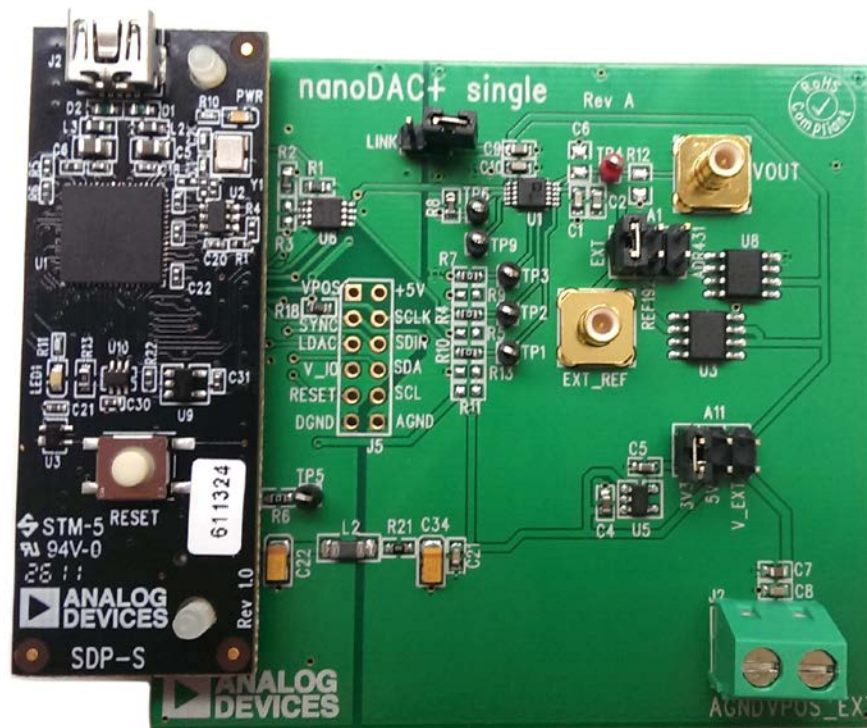

Figure 1. Universal Evaluation Board

TABLE OF CONTENTS

Features	1	Power Supplies.....	4
Package Contents.....	1	Link Options	4
Additional Equipment Needed	1	How to Use the Software	5
General Description	1	Running the Software	5
Evaluation Board Photograph.....	1	Software Operation	6
Revision History	2	Evaluation Board Schematics and Artwork	7
Getting Started	3	Ordering Information.....	10
Installing the Software	3	Components List	10
Evaluation Board Hardware.....	4		

REVISION HISTORY

1/14—Revision 0: Initial Version

GETTING STARTED

INSTALLING THE SOFTWARE

The [EVAL-AD5683RSDZ](#) evaluation kit includes self-installing software on CD. The software is compatible with Windows® XP (32-bit), Windows Vista (64-bit/32-bit), and Windows 7(64-bit/32-bit).

Install the software before connecting the SDP board to the USB port of the PC. This ensures that the SDP board is recognized when it connects to the PC.

1. Start the Windows® operating system and insert the CD.
2. The installation software will open automatically. If it does not, run the **setup.exe** file from the CD.
3. After installation is completed, power-up the evaluation board as described in the Power Supplies section.
4. Plug the [EVAL-AD5683RSDZ](#) into the SDP board and the SDP board into the PC using the USB cable included in the box.
5. When the software detects the evaluation board, proceed through any dialog boxes that appear to finalize the installation.

EVALUATION BOARD HARDWARE

POWER SUPPLIES

The [AD5683R](#) evaluation board can be powered either from the SDP or externally by the VPOS_EXT and AGND connector.

Both AGND and DGND inputs are provided on the board. The AGND and DGND planes are connected at one location close to the [AD5683R](#). It is recommended not to connect AGND and DGND elsewhere in the system to avoid ground loop problems.

All supplies are decoupled to ground with 10 μ F tantalum and 0.1 μ F ceramic capacitors.

Table 1. Power Supply Connectors

Connector No.	Voltage
J2-1	Analog positive power supply, V_EXT
J2-2	AGND

Table 3. Link Functions

Link No.	Option
A1	This link selects the DAC digital voltage source: Position A selects an external reference source via the SMB input EXT_REF. Position B selects the REF192 external reference. Position C selects the ADR431 external reference.
LINK	Connect only if the board of the part is controlled through the PMOD connector and the SDP is not connected.
A11	This link selects the DAC analog voltage source: Position A V _{DD} is powered @ 3.3 V. Position B V _{DD} is powered from unregulated USB supply. Position C V _{DD} is powered from an external supply voltage (V_EXT).

LINK OPTIONS

A number of link and switch options are incorporated in the evaluation board and should be set for the required operating setup before using the board. The functions of these link options are described in detail in Table 3. Table 2 describes the positions of the different links to control the evaluation board by PC, via the USB port and SDP board in single-supply mode.

Table 2. Link Options Setup for SDP Control (Default)

Link No.	Options
A11	A
LINK	Disconnected
A1	A

HOW TO USE THE SOFTWARE

RUNNING THE SOFTWARE

To run the program, do the following:

1. Click **Start > All Programs > Analog Devices > AD563R > AD5683R Evaluation Software**. (To uninstall the program, click **Start > Control Panel > Add or Remove Programs > AD5683R Evaluation Software**.)
2. If the SDP board is not connected to the USB port when the software is launched, a connectivity error is displayed (see Figure 2). Simply connect the evaluation board to the USB port of the PC, wait a few seconds, click **Rescan**, and follow the instructions.

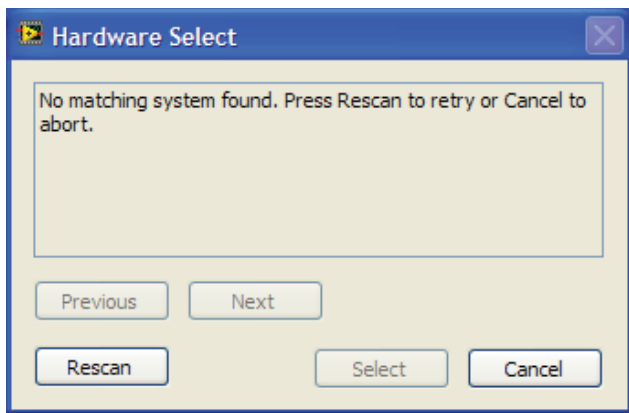

Figure 2. Pop-Up Window Error

3. If the SDP board is not connected to the evaluation boards, a message box appears as shown in Figure 3. Check the connection between the SDP and **EVAL-AD5683RSDZ** boards and run the program again. The software will now run in simulation mode enabling us to see how the **AD5683R** interface functions without the use of an evaluation board.



Figure 3. Error Message

4. If the SDP board is connected, the system development platform will connect for a brief period.



Figure 4. System Develop Platform Wait Window

5. The main window of the **AD5683R** evaluation software then opens, as shown in Figure 5.

Note that simulation mode is available and the software can be tested without the use of the evaluation boards.

SOFTWARE OPERATION

To select the [AD5683R](#) from the **Analog Devices** menu, click **Start > All Programs > Analog Devices > AD5683R > AD5683R SDP Evaluation Software**.

The [AD5683R](#) main window opens, as shown in Figure 5. The data programmed into the input register is displayed. You can update the command bits and the data bits by clicking the appropriate button under each area.

To select a command with which to program the part, select the appropriate button. For example, to program DAC output with full scale, write the full-scale value into the **INPUT VALUE (HEX)** (0xFFFF) text box and click **Write to Input and DAC register**.

The [AD5683R](#) control register options are available by selecting the drop-down menus and clicking **Write to Control Register**. Consult the [AD5683R](#) data sheet for details. Set $\overline{\text{LDAC}}$ and $\overline{\text{RESET}}$ to high or low by clicking the corresponding check boxes. This command is executed immediately.

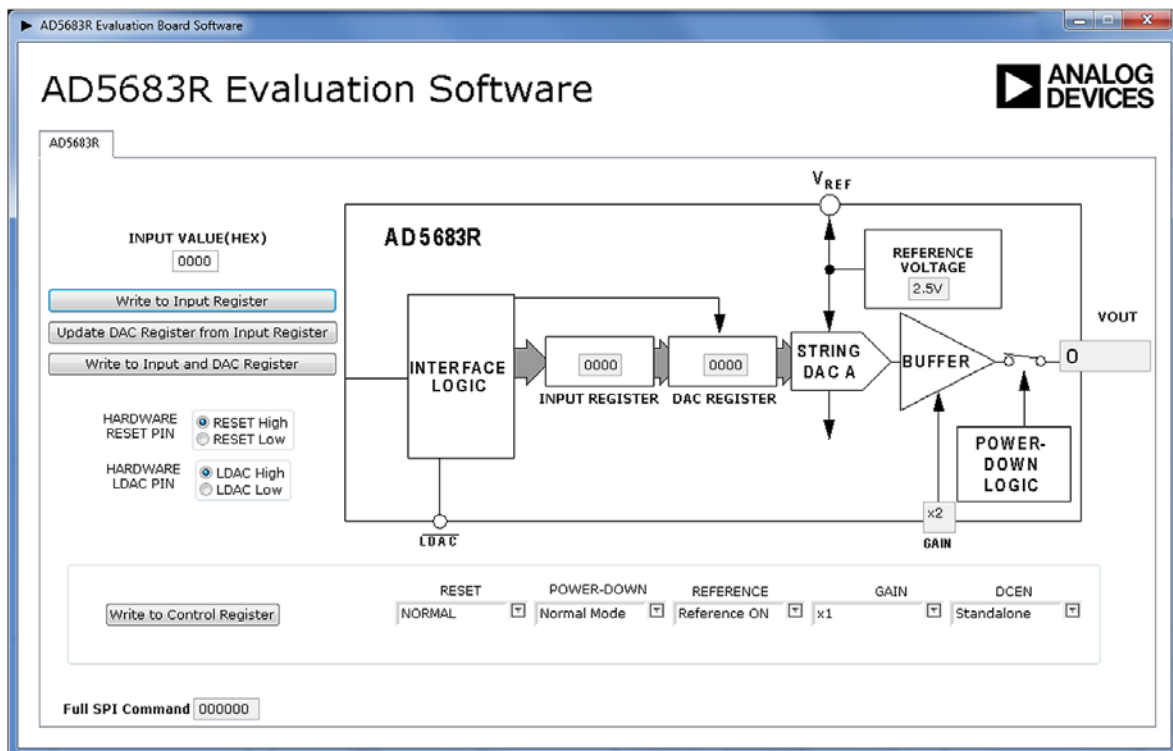

Figure 5. [AD5683R](#) Evaluation Board Main Window

EVALUATION BOARD SCHEMATICS AND ARTWORK

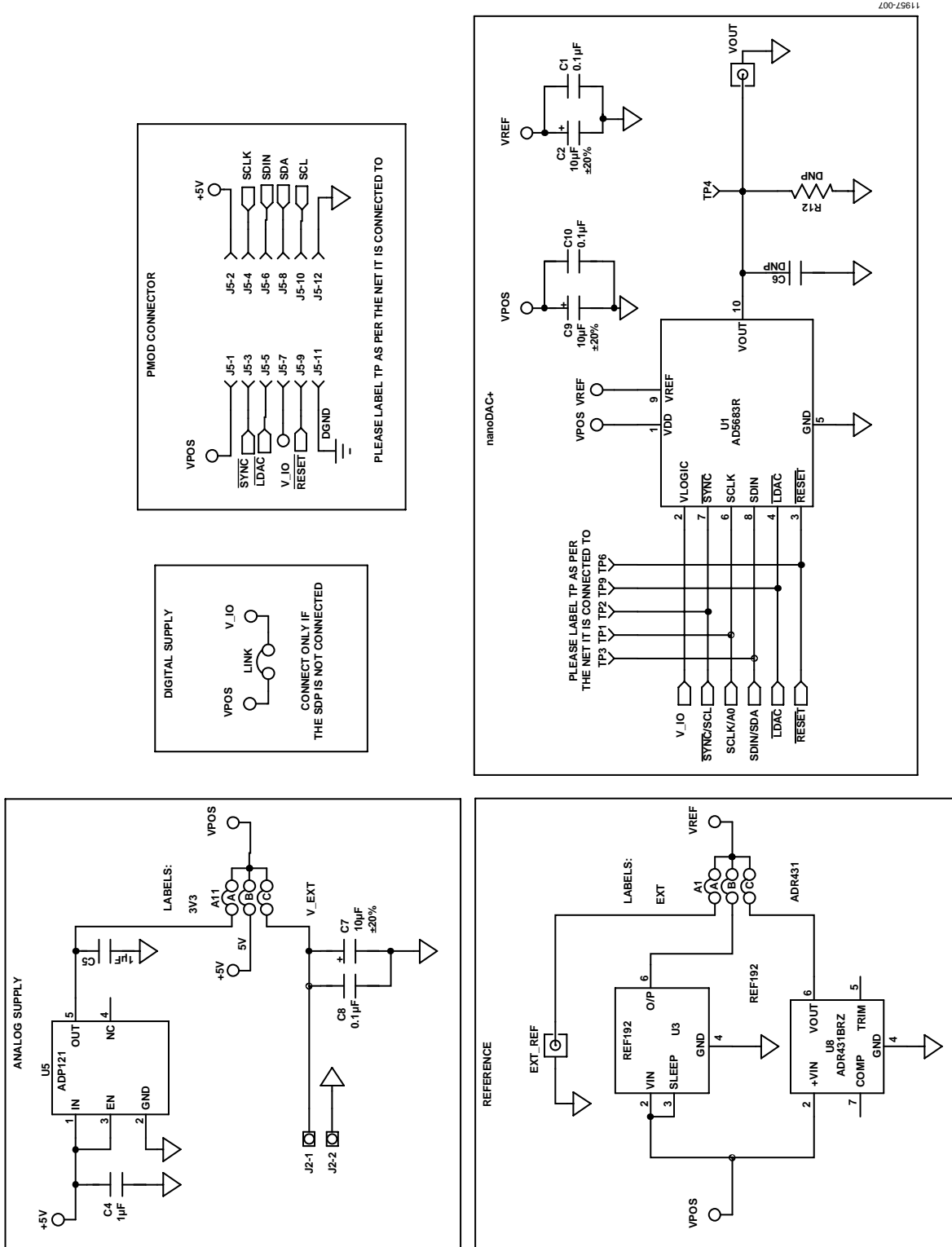

Figure 6. Schematic of AD5683R Evaluation Circuitry

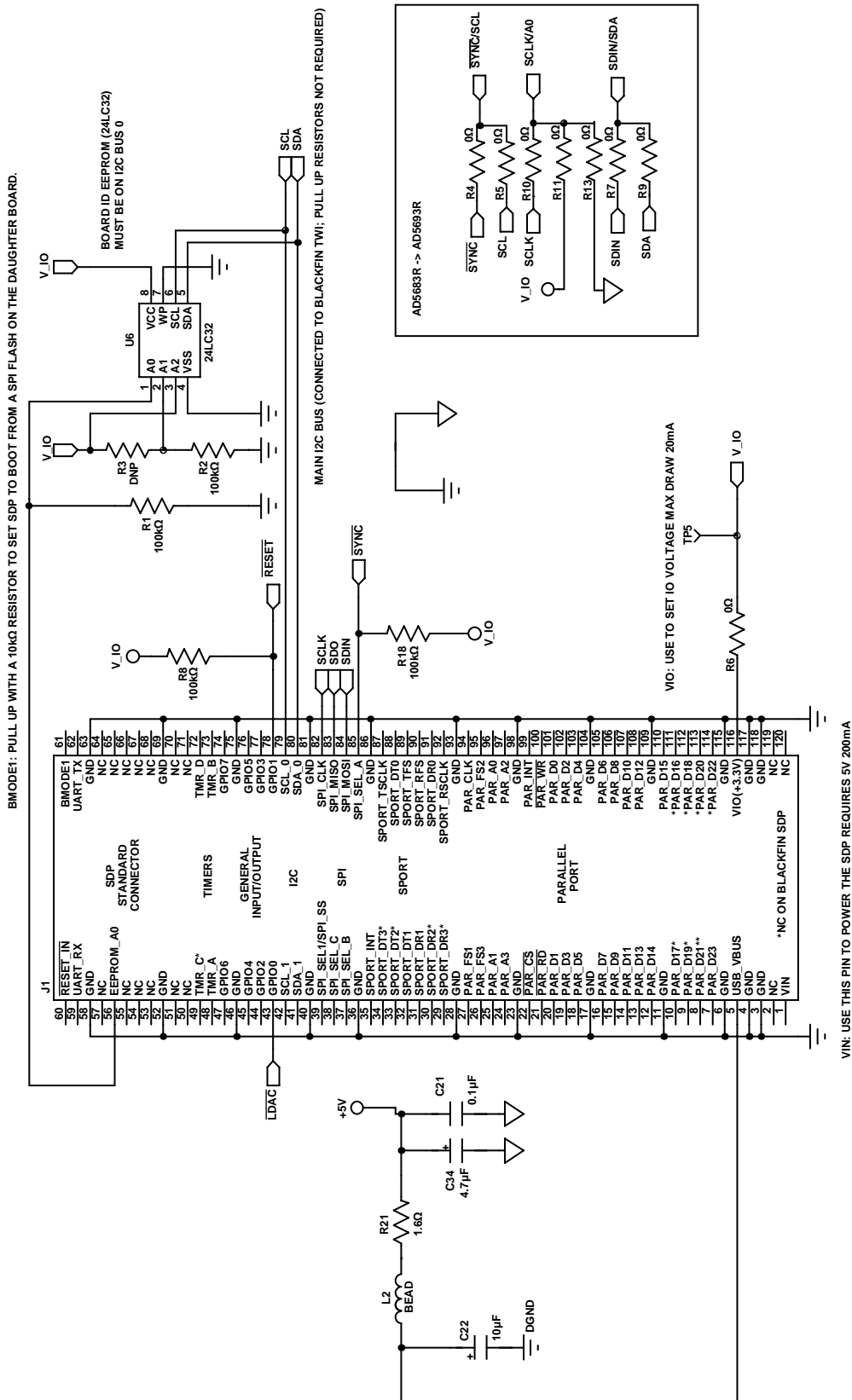

Figure 7. Schematic of SDP Connector

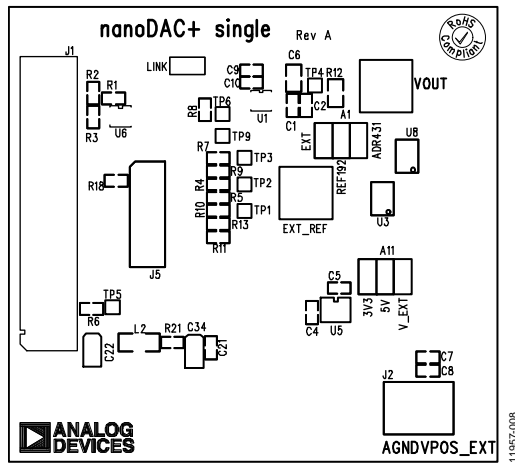

Figure 8. Component Placement Drawing

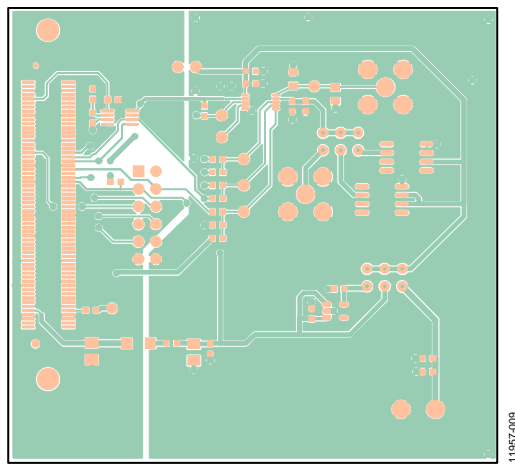

Figure 9. Component Side PCB Drawing

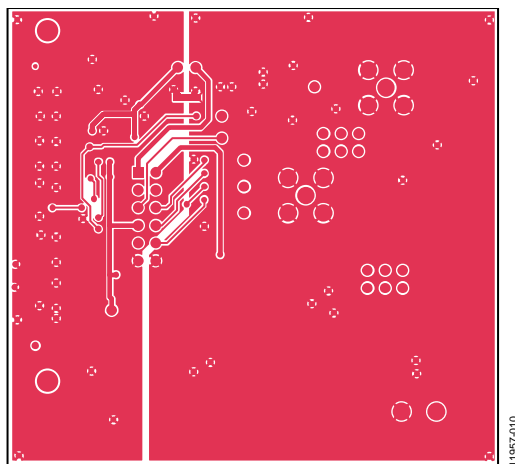

Figure 10. Solder Side PCB Drawing

ORDERING INFORMATION

COMPONENTS LIST

Table 4.

Qty	Reference	Description	Supplier/Part Number
1	U1	AD5683R	AD5683R
1	U3	2.5 V reference	REF192
1	U5	3.3 V regulator	ADP121
1	U6	32K I ² C serial EEPROM	FEC 1331330
1	U8	Ultralow noise XFET voltage references	ADR431BRZ
1	LINK	2-pin link	FEC 1022249
2	A1, A11	3-pin link	FEC 148535
2	VOUT, EXT_REF	SMB jack 50 Ω	FEC 1206013
1	J1	120-way female connector	FEC 1324660
1	J2	2-pin terminal block	FEC 151789
3	C1, C8, C10	0.1 μ F, 16 V X7R ceramic capacitor	FEC 1216538
1	C21	0.1 μ F, 50 V X7R ceramic capacitor	FEC 1759122
2	C4, C5	1 μ F, 16 V X7R ceramic capacitor	FEC 1658870
3	C2, C7, C9	10 μ F, 10 V, X5R, 0603	FEC 1853538
1	C22	10uF, 6.3 V, tantalum	FEC 1190107
1	L2	Inductor	FEC 9526862
7	TP1, TP2, TP3, TP4, TP5, TP6, TP9	Testpoint	FEC 8731128
4	R1, R2, R8, R18	100 k Ω SMD resistor	FEC 9330402
1	R21	1.6 Ω SMD resistor	FEC 1627674
4	R4, R6, R7, R10	0 Ω resistor	FEC 9331662

NOTES

NOTES

**ESD Caution**

ESD (electrostatic discharge) sensitive device. Charged devices and circuit boards can discharge without detection. Although this product features patented or proprietary protection circuitry, damage may occur on devices subjected to high energy ESD. Therefore, proper ESD precautions should be taken to avoid performance degradation or loss of functionality.

Legal Terms and Conditions

By using the evaluation board discussed herein (together with any tools, components documentation or support materials, the "Evaluation Board"), you are agreeing to be bound by the terms and conditions set forth below ("Agreement") unless you have purchased the Evaluation Board, in which case the Analog Devices Standard Terms and Conditions of Sale shall govern. Do not use the Evaluation Board until you have read and agreed to the Agreement. Your use of the Evaluation Board shall signify your acceptance of the Agreement. This Agreement is made by and between you ("Customer") and Analog Devices, Inc. ("ADI"), with its principal place of business at One Technology Way, Norwood, MA 02062, USA. Subject to the terms and conditions of the Agreement, ADI hereby grants to Customer a free, limited, personal, temporary, non-exclusive, non-sublicensable, non-transferable license to use the Evaluation Board FOR EVALUATION PURPOSES ONLY. Customer understands and agrees that the Evaluation Board is provided for the sole and exclusive purpose referenced above, and agrees not to use the Evaluation Board for any other purpose. Furthermore, the license granted is expressly made subject to the following additional limitations: Customer shall not (i) rent, lease, display, sell, transfer, assign, sublicense, or distribute the Evaluation Board; and (ii) permit any Third Party to access the Evaluation Board. As used herein, the term "Third Party" includes any entity other than ADI, Customer, their employees, affiliates and in-house consultants. The Evaluation Board is NOT sold to Customer; all rights not expressly granted herein, including ownership of the Evaluation Board, are reserved by ADI. CONFIDENTIALITY. This Agreement and the Evaluation Board shall all be considered the confidential and proprietary information of ADI. Customer may not disclose or transfer any portion of the Evaluation Board to any other party for any reason. Upon discontinuation of use of the Evaluation Board or termination of this Agreement, Customer agrees to promptly return the Evaluation Board to ADI. ADDITIONAL RESTRICTIONS. Customer may not disassemble, decompile or reverse engineer chips on the Evaluation Board. Customer shall inform ADI of any occurred damages or any modifications or alterations it makes to the Evaluation Board, including but not limited to soldering or any other activity that affects the material content of the Evaluation Board. Modifications to the Evaluation Board must comply with applicable law, including but not limited to the RoHS Directive. TERMINATION. ADI may terminate this Agreement at any time upon giving written notice to Customer. Customer agrees to return to ADI the Evaluation Board at that time. LIMITATION OF LIABILITY. THE EVALUATION BOARD PROVIDED HEREUNDER IS PROVIDED "AS IS" AND ADI MAKES NO WARRANTIES OR REPRESENTATIONS OF ANY KIND WITH RESPECT TO IT. ADI SPECIFICALLY DISCLAIMS ANY REPRESENTATIONS, ENDORSEMENTS, GUARANTEES, OR WARRANTIES, EXPRESS OR IMPLIED, RELATED TO THE EVALUATION BOARD INCLUDING, BUT NOT LIMITED TO, THE IMPLIED WARRANTY OF MERCHANTABILITY, TITLE, FITNESS FOR A PARTICULAR PURPOSE OR NON-INFRINGEMENT OF INTELLECTUAL PROPERTY RIGHTS. IN NO EVENT WILL ADI AND ITS LICENSORS BE LIABLE FOR ANY INCIDENTAL, SPECIAL, INDIRECT, OR CONSEQUENTIAL DAMAGES RESULTING FROM CUSTOMER'S POSSESSION OR USE OF THE EVALUATION BOARD, INCLUDING BUT NOT LIMITED TO LOST PROFITS, DELAY COSTS, LABOR COSTS OR LOSS OF GOODWILL. ADI'S TOTAL LIABILITY FROM ANY AND ALL CAUSES SHALL BE LIMITED TO THE AMOUNT OF ONE HUNDRED US DOLLARS (\$100.00). EXPORT. Customer agrees that it will not directly or indirectly export the Evaluation Board to another country, and that it will comply with all applicable United States federal laws and regulations relating to exports. GOVERNING LAW. This Agreement shall be governed by and construed in accordance with the substantive laws of the Commonwealth of Massachusetts (excluding conflict of law rules). Any legal action regarding this Agreement will be heard in the state or federal courts having jurisdiction in Suffolk County, Massachusetts, and Customer hereby submits to the personal jurisdiction and venue of such courts. The United Nations Convention on Contracts for the International Sale of Goods shall not apply to this Agreement and is expressly disclaimed.