

THIS DOCUMENT IS THE PROPERTY OF
KEYSTONE ELECTRONICS CORP. AND
SHALL NOT BE REPRODUCED, DISTRIBUTED
OR USED AS A BASIS FOR MANUFACTURE
WITHOUT PRIOR WRITTEN PERMISSION
FROM KEYSTONE ELECTRONICS CORP.

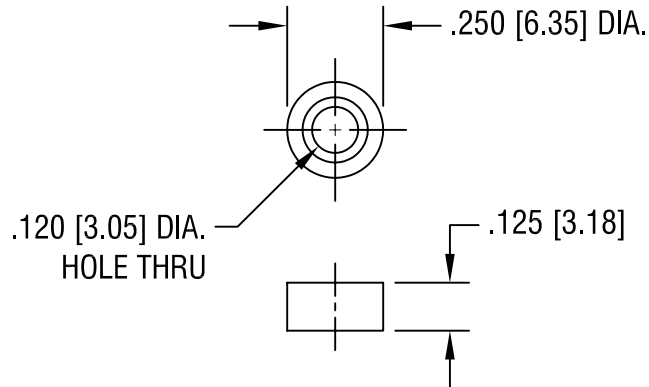

KEYSTONE ELECTRONICS CORP.

ASTORIA, N.Y. 11105-2017

PART NAME

CLEAR THRU-HOLE SPACER

MATERIAL

ALUMINUM

FINISH

CLEAR IRIDITE

DRN BY

BOONE

DATE

1.3.97

APPD

LN

SCALE

2X

TOLERANCES

INCH [MM]

DECIMAL $\pm .005$ [± 0.15]

ANGULAR $\pm 1^\circ$

UNLESS OTHERWISE SPECIFIED

CODE

C/M

DWG NO.

2036

DATE

DESCRIPTION

REV.