

MAX3748H Evaluation Kit

Evaluates: MAX3748H

General Description

The MAX3748H evaluation kit (EV kit) simplifies evaluation of the MAX3748H limiting amplifier. The fully assembled and tested EV kit allows for quick threshold level selections, provides an RSSI output signal (when used with the MAX3744), and includes a calibration circuit.

EV Kit Contents

◆ MAX3748H EV Kit Board

DESIGNATION	QTY	DESCRIPTION
C1, C2, C7, C10	4	0.001 μ F \pm 10%, 10V min ceramic capacitors (0201)
C3, C4, C6, C8, C9, C11, C12, C14–C18	12	0.1 μ F \pm 10%, 10V min ceramic capacitors (0402)
C20	1	2.2 μ F \pm 10%, 10V min ceramic capacitor (0805)
C21	1	33 μ F \pm 5%, 10V min tantalum capacitor (B case)
J1–J8	8	SMA edge-mount tab connectors Johnson 142-0701-851
JU2–JU5, JU9, JU11	6	2-pin jumper blocks, 0.1in spacing
JU6, JU7, JU8	3	3-pin jumper blocks, 0.1in spacing
L1	1	1.2 μ H \pm 5% chip inductor Coilcraft 1008LS

Features

- ◆ Fully Assembled and Tested
- ◆ Test Point for Easy LOS Monitoring
- ◆ Polarity Reversal Control
- ◆ Selectable Offset Correction Loop Capacitance
- ◆ Jumpers Allow Quick Selection for LOS Threshold Level

[Ordering Information](#) appears at end of data sheet.

Component List

DESIGNATION	QTY	DESCRIPTION
R3		82 Ω \pm 5% resistor (0201)
R4	1	270 Ω \pm 5% resistor (0201)
R5	1	20k Ω \pm 1% resistor (0201)
R6	1	4.75k Ω \pm 1% resistor (0402)
R7	1	10k Ω \pm 1% resistor (0402)
R8	1	3.01k Ω \pm 1% resistor (0402)
TP2, TP3, TP9, TP10, J10, J11	4	Test points Digi-Key 5000K-ND
JU2–JU9, JU11	9	Shunts
U1	1	Limiting amplifier Maxim MAX3748HEGE+ (16 TQFN-EP*)
—	1	PCB: MAX3748H EVALUATION BOARD REV A

+Denotes a lead(Pb)-free/RoHS-compliant package.

*EP = Exposed pad.

Component Suppliers

SUPPLIER	PHONE	WEBSITE
AVX	843-946-0238	www.avx.com
Coilcraft	847-639-6400	www.coilcraft.com
Murata Electronics North America	770-436-1300	www.murata-northamerica.com

Note: Indicate that you are using the MAX3748H when ordering from these suppliers.

MAX3748H Evaluation Kit

Evaluates: MAX3748H

Quick Start

- 1) Connect OUT+ and OUT- to a 50Ω terminated oscilloscope.
- 2) Connect IN+ and IN- to a 500mV_{P-P}, 3.2Gbps differential data stream.
- 3) Remove all shunts.
- 4) Shunt JU8 to VCC so that there is no inversion of signal polarity (OUTPOL, VCC). [Figure 2](#) shows the jumper diagram for the board.
- 5) Shunt JU4 connecting R3 = 82Ω (R_{TH}).
- 6) Shunt JU6 connecting R7 = 10kΩ (R_{LOS}).
- 7) Shunt JU5 connecting pin LOS to DISABLE.
- 8) Connect TP2 to VCC.
- 9) Shunt jumper JU11 so that the capacitor C12 is connected to pins CAZ1 and CAZ2.
- 10) Connect the power-supply ground to the GND pad and then connect a +3.3V power supply to the VCC.
- 11) Observe a limited signal at the output, approximately 0.8V_{P-P}.
- 12) Lower the amplitude of the input signal from 500mV_{P-P} to 15mV_{P-P} or less. The output signal is squelched.

Table 1. Adjustment and Control Descriptions (see [Quick Start](#) first)

NAME	FUNCTION
JU2, JU3, JU4	Selects LOS assert/deassert level.
JU5	Shunt to connect the LOS pin to the DISABLE pin (squelch).
JU6	Shunt to connect series resistor from LOS to test point TP2. Make sure TP2 is connected to a positive supply.
JU7	Disable. Shunting to VCC holds the outputs static.
JU8	Shunt to GND to reverse the output signal's polarity (OUTPOL). Shunt to VCC for normal operation.
JU9	Shunt to connect RSSI output to RSSI resistor R8.
JU11	Shunt to connect C12 to CAZ1 and CAZ2.

MAX3748H Evaluation Kit

Evaluates: MAX3748H

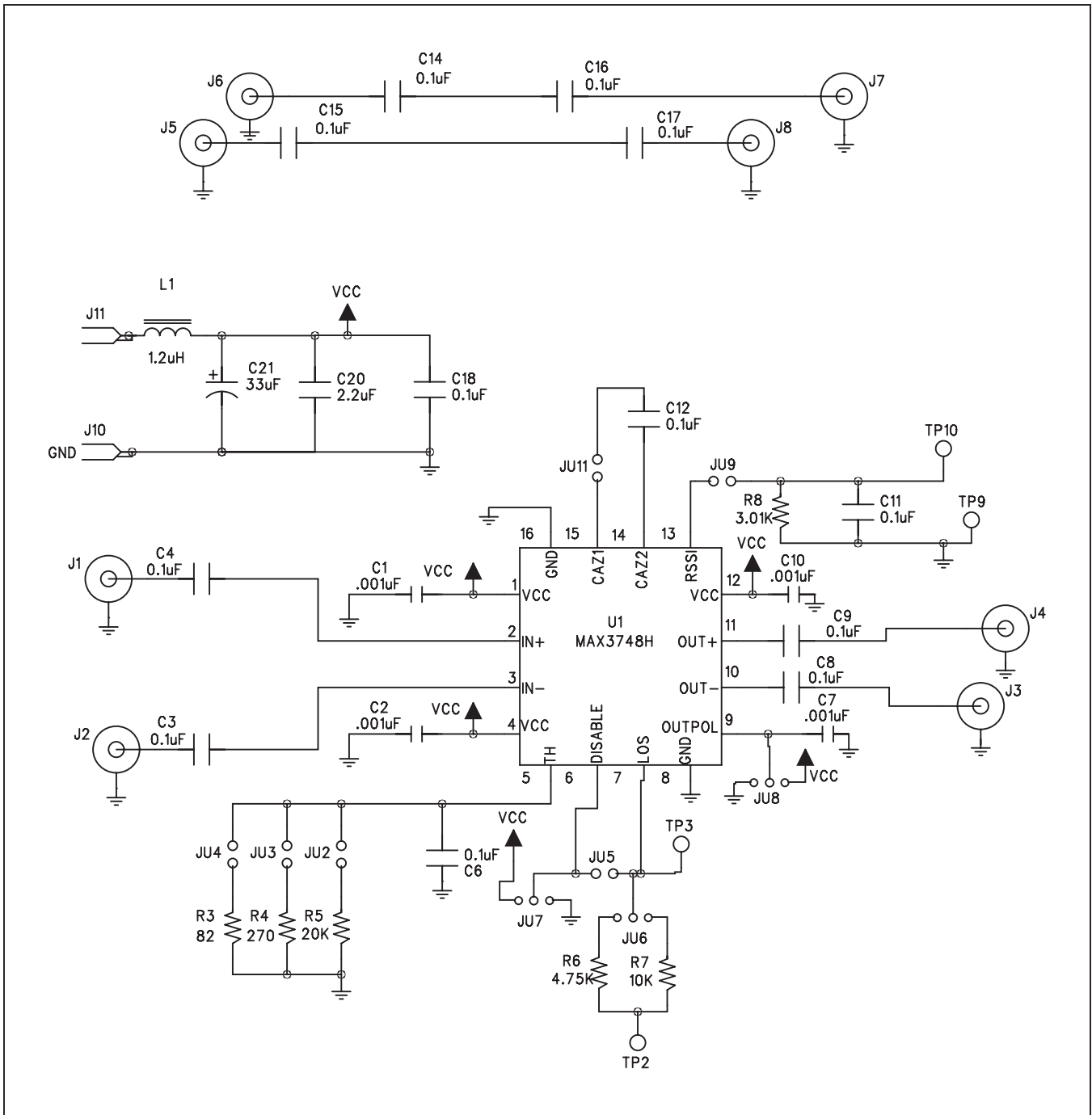

Figure 1. MAX3748H EV Kit Schematic

MAX3748H Evaluation Kit

Evaluates: MAX3748H

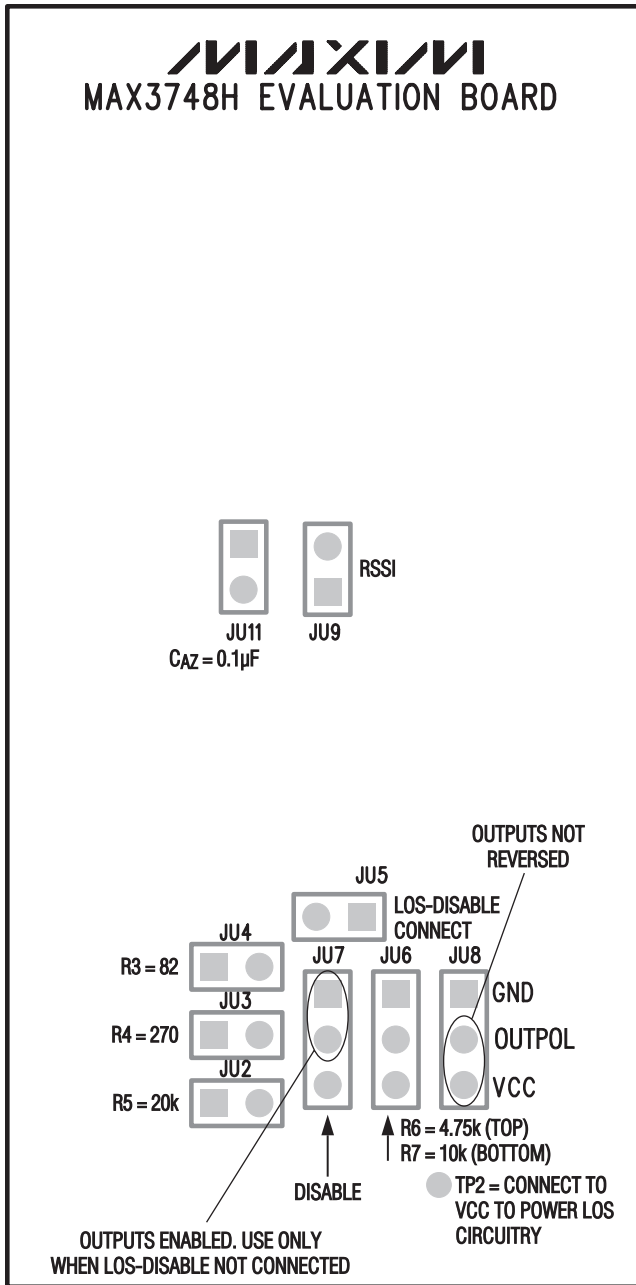

Figure 2. Jumper Diagram

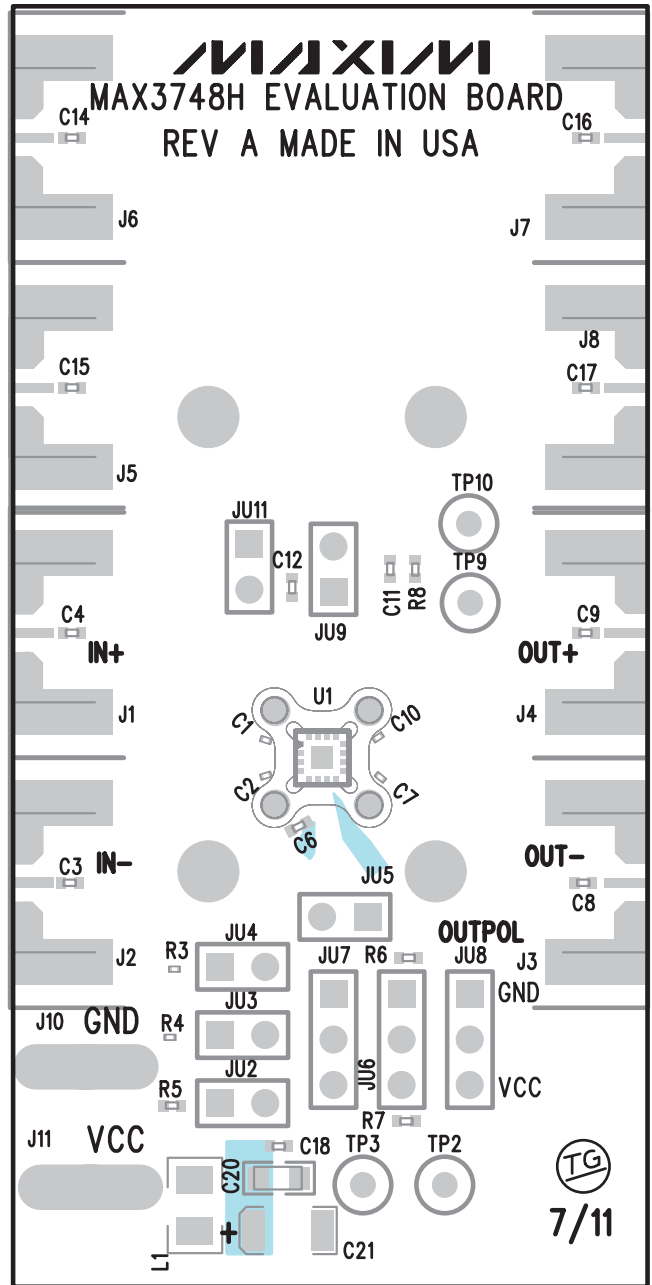

Figure 3. MAX3748H EV Kit Component Placement Guide—Component Side (2X)

MAX3748H Evaluation Kit

Evaluates: MAX3748H

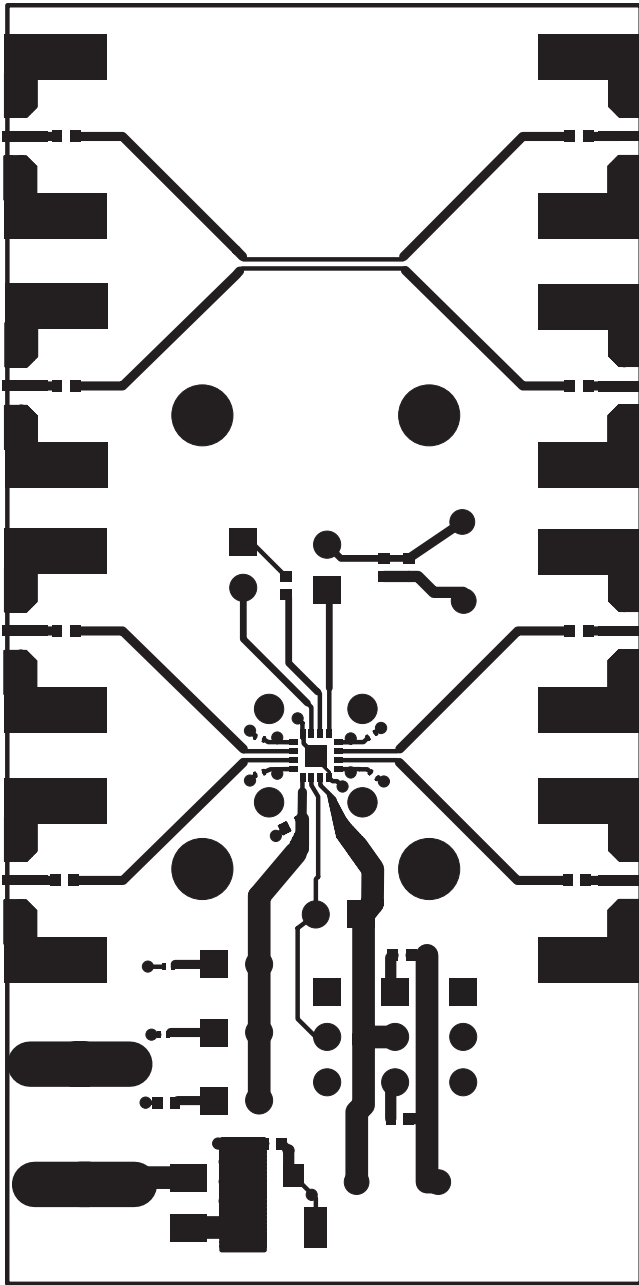

Figure 4. MAX3748H EV Kit PCB Layout—Component Side (2X)

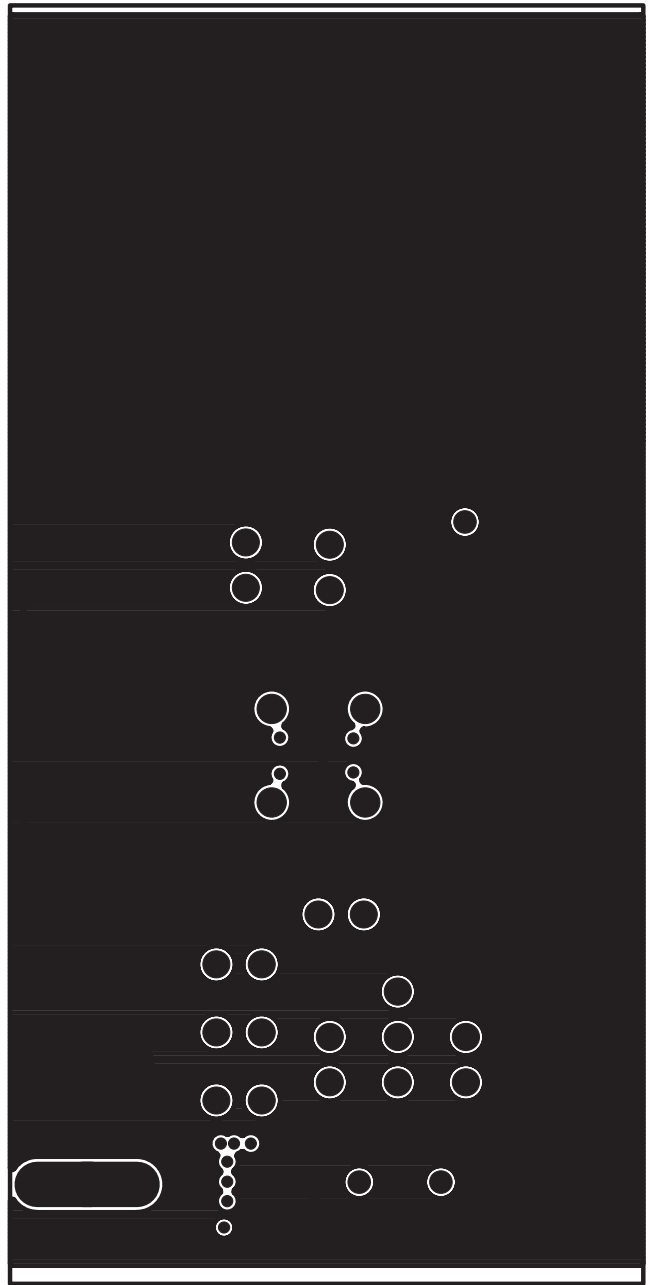

Figure 5. MAX3748H EV Kit PCB Layout—Ground Plane (2X)

MAX3748H Evaluation Kit

Evaluates: MAX3748H

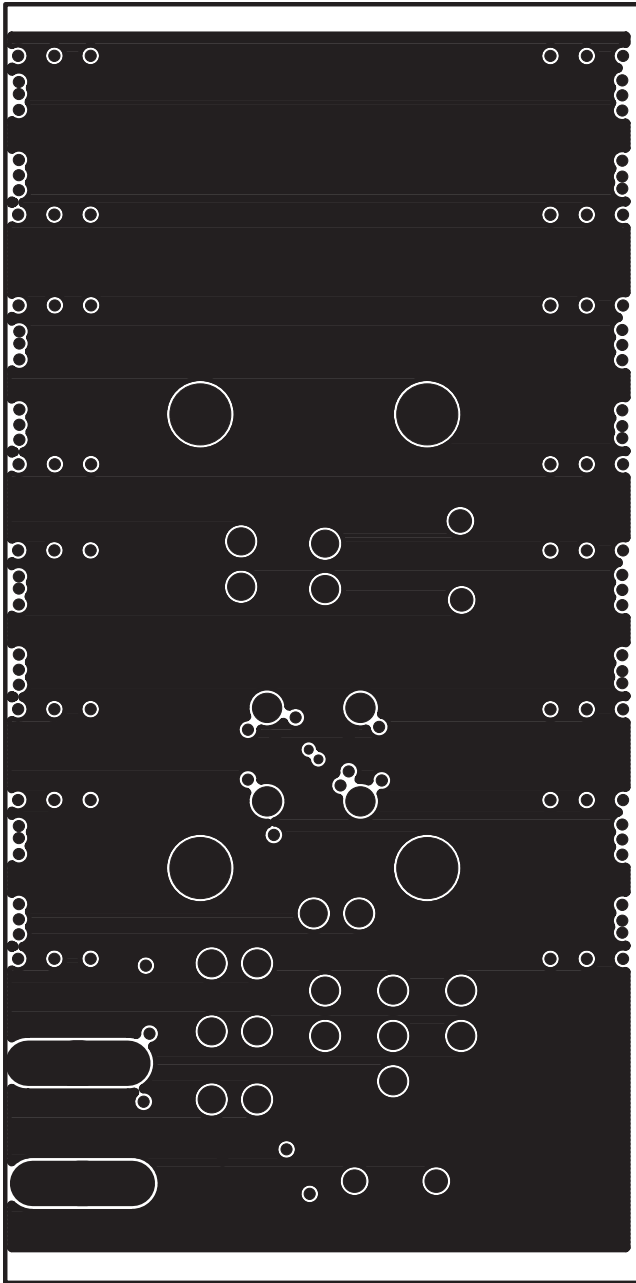

Figure 6. MAX3748H EV Kit PCB Layout—Power Plane (2X)

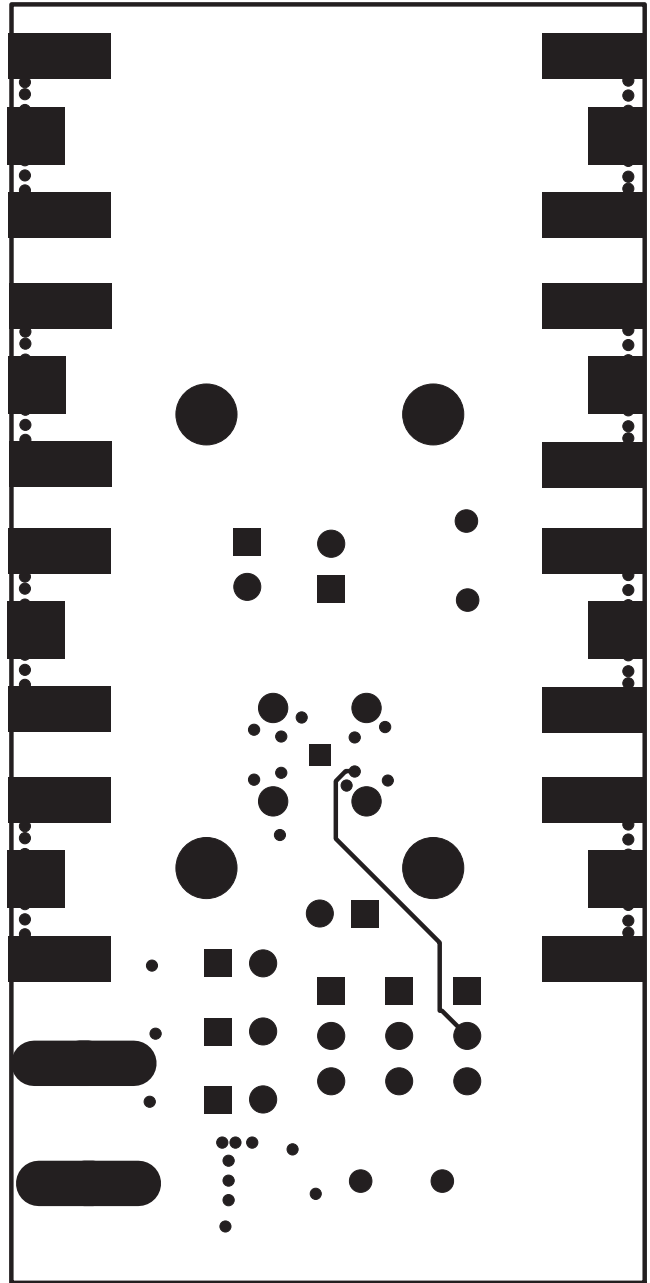

Figure 7. MAX3748H EV Kit PCB Layout—Solder Side (2X)

MAX3748H Evaluation Kit

Evaluates: MAX3748H

Ordering Information

PART	TYPE
MAX3748HEVKIT	EV Kit

MAX3748H Evaluation Kit

Evaluates: MAX3748H

Revision History

REVISION NUMBER	REVISION DATE	DESCRIPTION	PAGES CHANGED
0	8/11	Initial release	—

Maxim cannot assume responsibility for use of any circuitry other than circuitry entirely embodied in a Maxim product. No circuit patent licenses are implied. Maxim reserves the right to change the circuitry and specifications without notice at any time.

Maxim Integrated Products, 120 San Gabriel Drive, Sunnyvale, CA 94086 408-737-7600 _____ 8