

# LTM4608: Low $V_{IN}$ , 8A DC/DC $\mu$ Module<sup>®</sup> with Tracking, Margining and Frequency Synchronization

## DESCRIPTION

Demonstration circuit DC1181B features the LTM<sup>®</sup>4608EV, the high efficiency, high density switch mode step-down power module. The input voltage range is from 2.7V to 5.5V. The output voltage is jumper selectable from 0.596V to 3.3V; refer to step down ratio curve in the LTM4608 data sheet. The rated load current is 8A, while de-rating is necessary for certain  $V_{IN}$ ,  $V_{OUT}$  and thermal conditions. Integrated input and output filters enable a simple PCB layout. Only bulk input and output capacitors are needed externally. The LTM4608 allows the user to program output

ramp-up and ramp-down through the TRACK/SS pin. The output can be set to coincidentally or ratiometrically track to another voltage rail. Margining function is provided for the user who wants to stress their systems by varying supply voltages during testing; refer to data sheet for Functional Diagram.

**Design files for this circuit board are available at <http://www.linear.com/demo>**

LT, LT, LTC, LTM,  $\mu$ Module, Linear Technology and the Linear logo are registered trademarks of Linear Technology Corporation. All other trademarks are the property of their respective owners.

**Table 1. Performance Summary ( $T_A = 25^\circ\text{C}$ )**

| PARAMETER                         | CONDITION  | VALUE                                   |
|-----------------------------------|--|---|
| Minimum Input Voltage             |  | 2.7V                                    |
| Maximum Input Voltage             |  | 5.5V                                    |
| Output Voltage $V_{OUT}$          | Jumper selectable (open for 0.596V)  | 1.2V, 1.5V, 1.8V, 2.5V, 3.3V; $\pm 2\%$ |
| Maximum Continuous Output Current | De-rating is necessary for certain $V_{IN}$ , $V_{OUT}$ , and thermal conditions | $8A_{DC}$                               |
| Default Operating Frequency       |  | 1.5MHz                                  |
| Efficiency                        | $V_{IN} = 5V$ , $V_{OUT} = 1.5V$ , $I_{OUT} = 8A$                                | 77%, See Figure 4 for more information  |
| Load Transient                    | $V_{IN} = 3.3V$ , $V_{OUT} = 1.2V$   | See Figure 3 for details                |

# DEMO MANUAL DC1181B

## QUICK START PROCEDURE

Demonstration circuit DC1181B is easy to set up to evaluate the performance of the LTM4608EV. Please refer to Figure 1 for proper measurement equipment setup and follow the procedure below:

1. Place jumpers in the following positions for a typical 1.2V<sub>OUT</sub> application:

| V <sub>OUT</sub> SELECT | RUN | TRACK | MARGINING |
|-------------------------|-----|-------|-----------|
| 1.2V                    | ON  | OFF   | NO        |

2. With power off, connect the input power supply, load and meters as shown in Figure 1. Preset the load to 0A and V<sub>IN</sub> supply to be less than 5.5V.
3. Turn on the power at the input. The output voltage should be 1.2V ±2%.
4. Once the proper output voltage is established, adjust the load within the operating range and observe the output voltage regulation, ripple voltage, efficiency and other parameters
5. To measure input and output ripple, please refer to Figure 2 for proper setup.

6. For optional load transient test, apply adjustable pulse signal between IOSTEP CLK and GND pins. Pulse amplitude sets the current step. The pulse signal should have very small duty cycle (<5%) to limit the thermal stress on the transient load circuit. The output transient current can be monitored at BNC connector J5 (10mV/A), the output voltage can be monitored at BNC connector J6.
7. If V<sub>OUT</sub> is set to 2.5V or 3.3V, and the margining function is not desired, then the MGN pin should not be connected to V<sub>OUT</sub> anymore. Instead, add a voltage divider from V<sub>IN</sub> to GND with the center point tied to the MGN pin to disable margining. Each resistor should be close to 50k. For lower outputs (≤1.8V), no change is necessary.

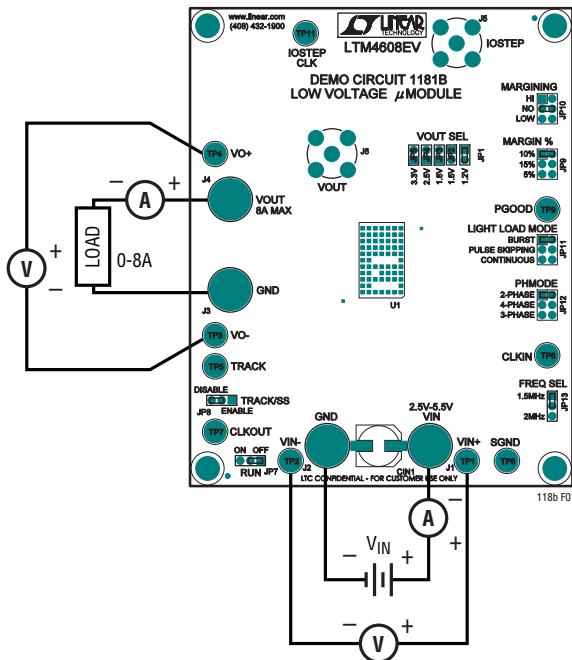

Figure 1. Test Setup of DC1181B

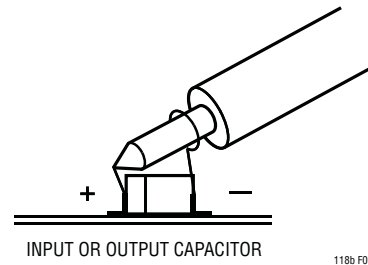

Figure 2. Scope Probe Placement for Measuring Input or Output Ripple

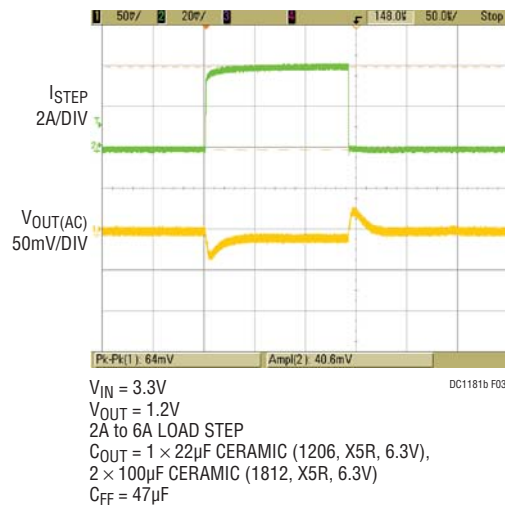
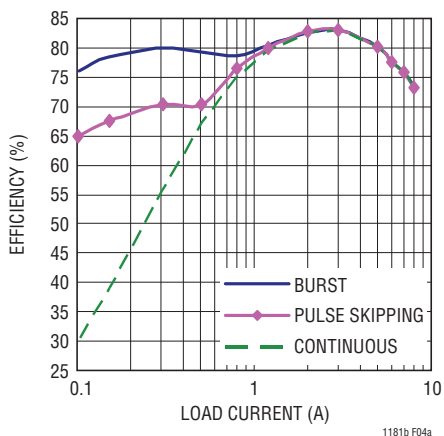

Figure 3. Measured Load Transient Response (4A Step, 25% to 75%)

## QUICK START PROCEDURE

Efficiency vs Load Current with 5V<sub>IN</sub> 1.2V<sub>OUT</sub>



Efficiency vs Load Current with 5V<sub>IN</sub> 1.5V<sub>OUT</sub>

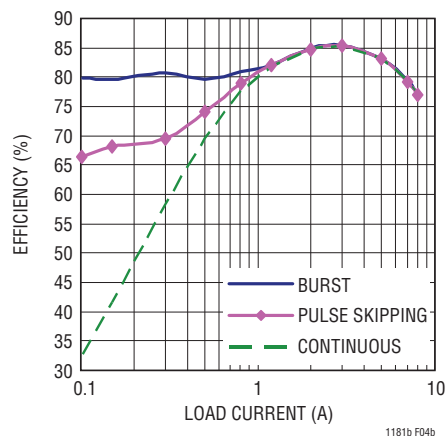

Efficiency vs Load Current with 3.3V<sub>IN</sub> 1.2V<sub>OUT</sub>

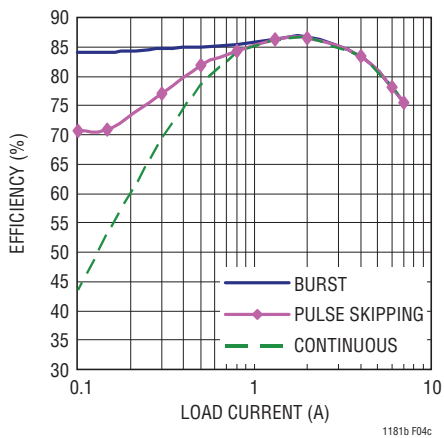

Efficiency vs Load Current with 3.3V<sub>IN</sub> 1.5V<sub>OUT</sub>

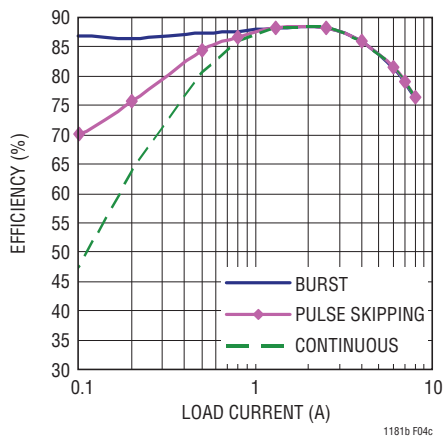

Figure 4. Measured Supply Efficiency with Different V<sub>IN</sub> and V<sub>OUT</sub>

# DEMO MANUAL DC1181B

---

## PARTS LIST

| ITEM                                | QUANTITY | REFERENCE-DESCRIPTION | DESCRIPTION                   | MANUFACTURERS PART NUMBER |
|-------------------------------------|----------|-----------------------|-------------------------------|---------------------------|
| <b>REQUIRED CIRCUIT COMPONENTS:</b> |          |                       |                               |                           |
| 1                                   | 1        | CFF                   | CAP, 0603 47pF 10% 25V NPO    | AVX 06033A470KAT          |
| 2                                   | 1        | CIN1                  | CAP, 150uF 20% 10V ELEC       | SANYO 10SVPA150MAA        |
| 3                                   | 2        | CIN5, CIN4            | CAP, 0805 10uF 10% 6.3V X5R   | AVX 08056D106KAT2A        |
| 4                                   | 1        | C03                   | CAP, 1206 22uF 20% 6.3V X5R   | AVX 12066D266MAT2A        |
| 5                                   | 2        | C05, C04              | CAP, 1812 100uF 20% 6.3V X5R  | TDK C4532X5R0J107MZ       |
| 6                                   | 1        | R14                   | RES, 0603 9.76K OHMS 1% 1/10W | VISHAY CRCW06039K76FKEA   |
| 7                                   | 1        | U1                    | IC, LOW VOLTAGE POWER MODULE  | LINEAR TECH. LTM4608EV    |

**SCHEMATIC DIAGRAM**

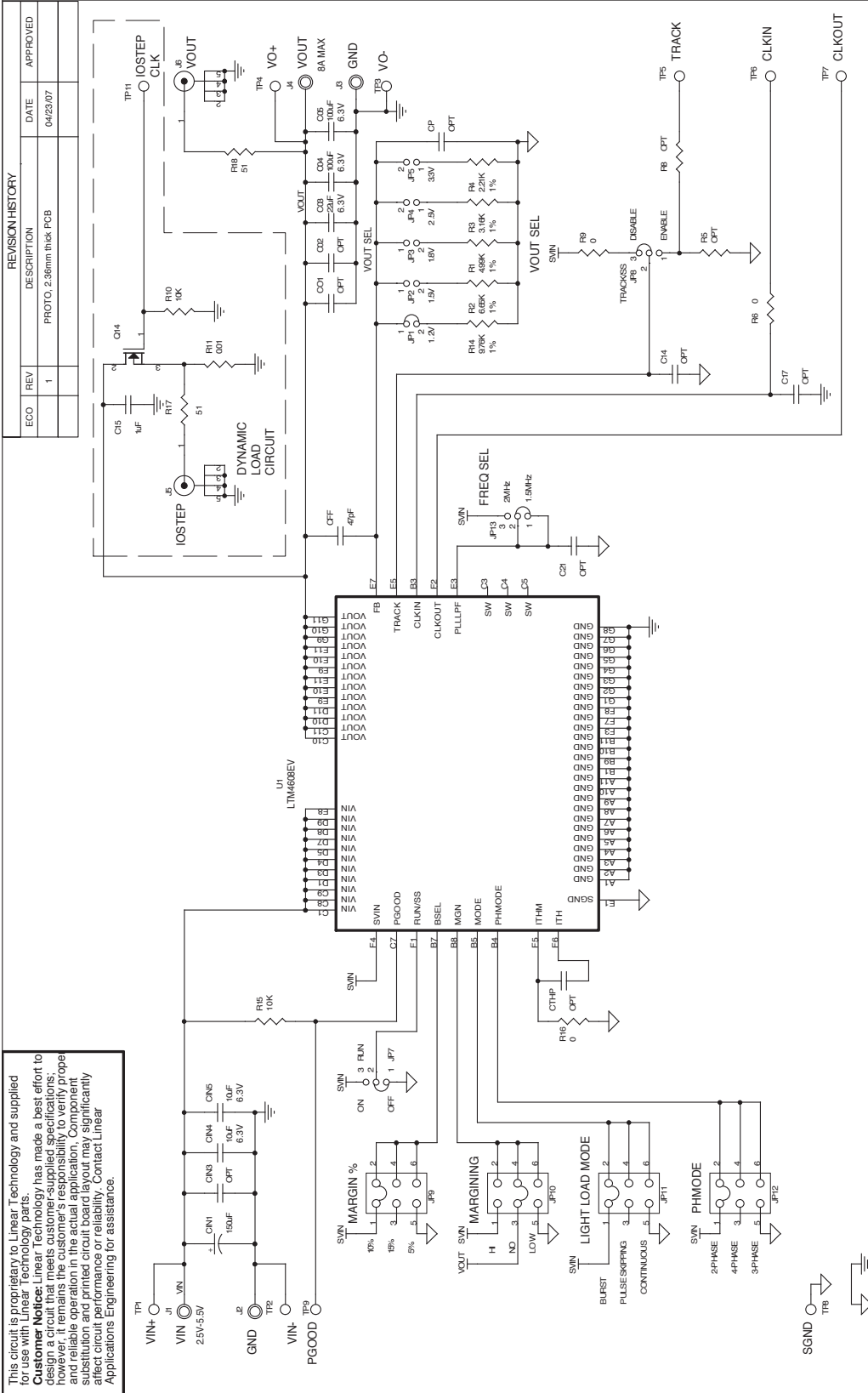

This circuit is proprietary to Linear Technology and supplied for use with Linear Technology parts.  
**Customer Notice:** Linear Technology has made a best effort to design a circuit that meets customer-supplied specifications; however, it remains the customer's responsibility to verify proper operation of the circuit. The customer is responsible for any substitutions and/or circuit board layout that may significantly affect circuit performance or reliability. Contact Linear Applications Engineering for assistance.

| REVISION HISTORY |     |                         |          |          |
|------------------|-----|-------------------------|----------|----------|
| ECCO             | REV | DESCRIPTION             | DATE     | APPROVED |
|                  | 1   | PROTO, 2.38mm thick PCB | 04/23/07 |          |

|   |                        |  |                   |
|---|------------------------|--|-------------------|
|   |                        | 1650 McCarthy Blvd<br>Milpitas, CA 95035<br>Phone: (408)451-1900<br>Fax: (408)451-0077 |                   |
| CONTRACT NO.  |                        | TITLE: SCH, LTM4608EV, LOW VOLTAGE μMODULE   |                   |
| APPROVALS<br>DRAWN: MEI   | DATE<br>04/23/07       | SIZE<br>CAGE CODE  | DWG NO<br>DC1181B |
| CHECKED<br>APPROVED<br>ENGINEER<br>DESIGNER   | FILENAME<br>1181B-3DSN | SCALE<br>NONE  | SHEET<br>1 OF 1   |
| UNLESS OTHERWISE SPECIFIED<br>DIMENSIONS ARE IN INCHES<br>DECIMALS OR FRACTIONS<br>2 PLACES ... 0.00, 0.01, 0.02 ...<br>INTERPRET DIM AND TOL<br>PER ASME Y14.5M-1994 |                        | DO NOT SCALE DRAWING   |                   |
|   |                        | TUESDAY, MAY 08, 2007  |                   |

## PCB LAYOUT AND FILM

Top Silkscreen

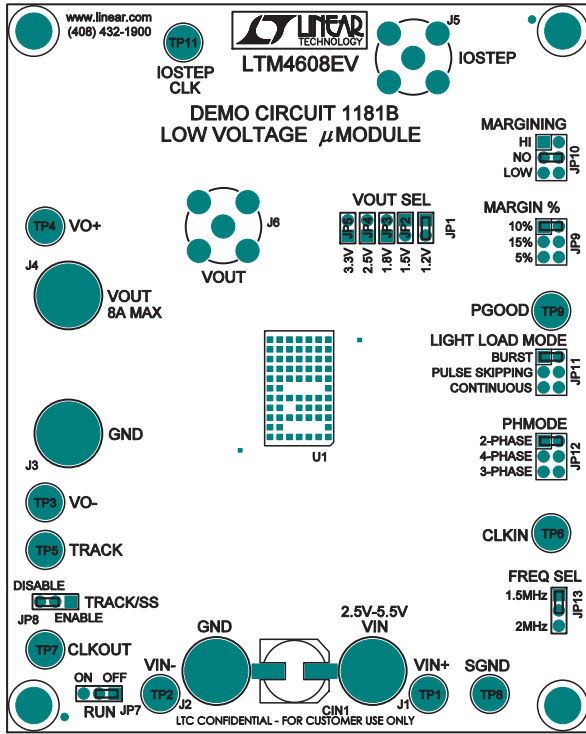

Top Paste

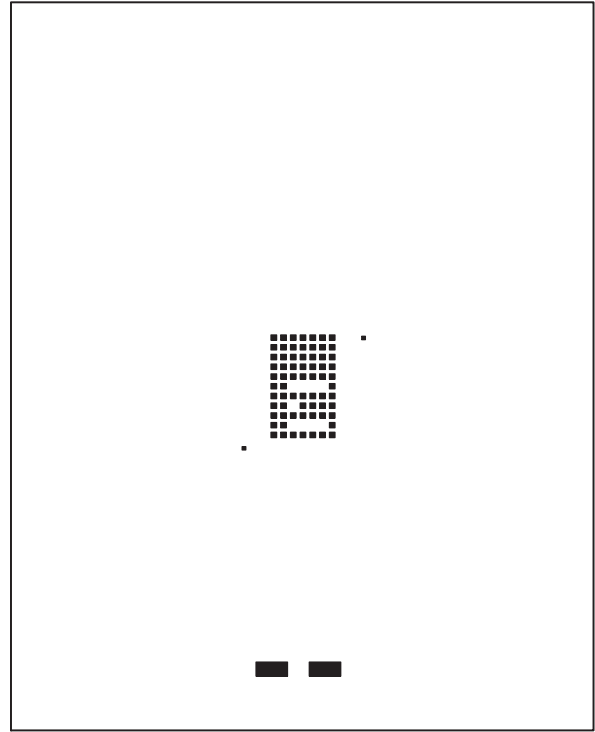

Component Side

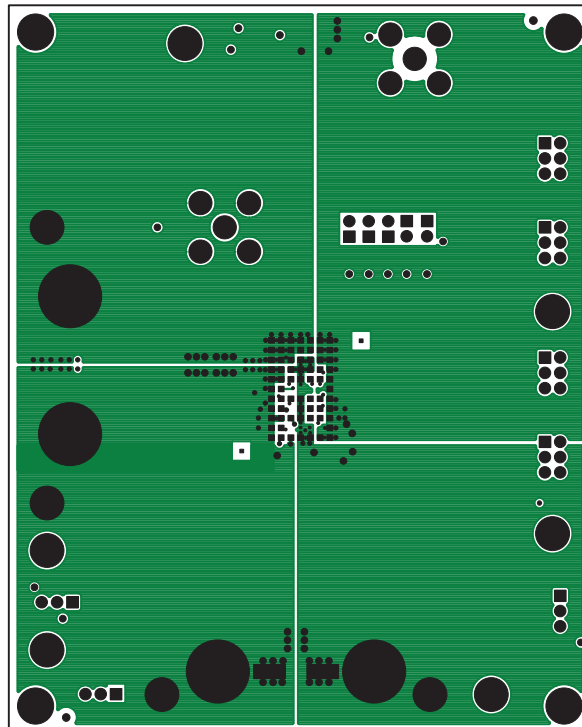

PCB LAYOUT AND FILM

GND Layer

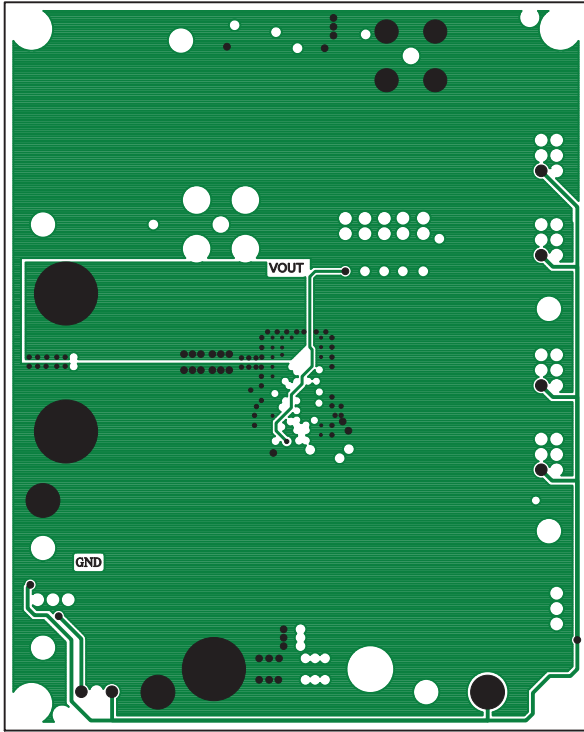

GND Layer

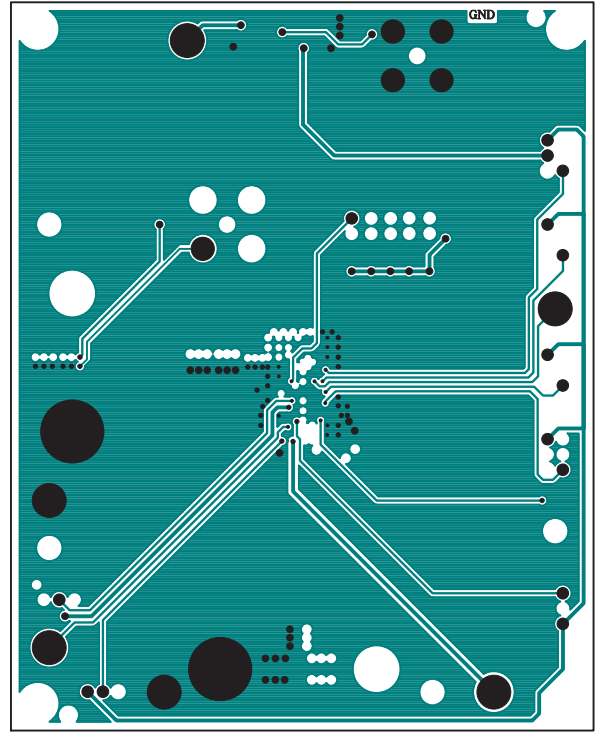

Bottom Layer

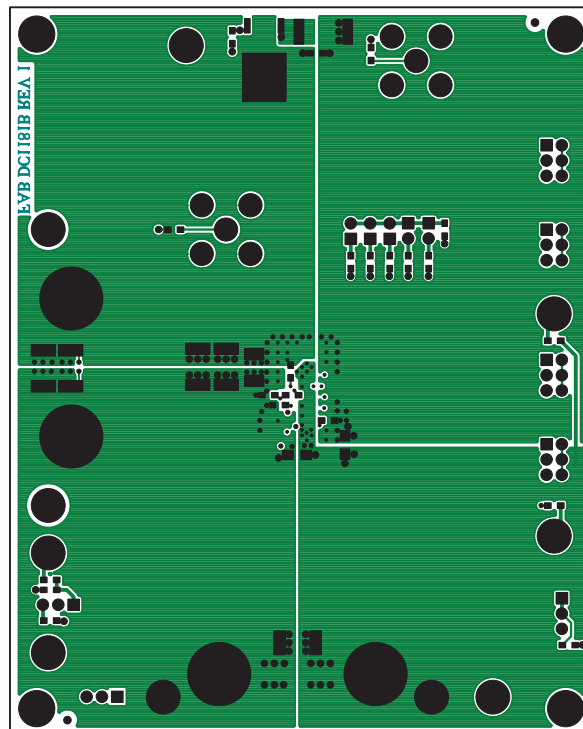

# DEMO MANUAL DC1181B

---

## DEMONSTRATION BOARD IMPORTANT NOTICE

Linear Technology Corporation (LTC) provides the enclosed product(s) under the following **AS IS** conditions:

This demonstration board (DEMO BOARD) kit being sold or provided by Linear Technology is intended for use for **ENGINEERING DEVELOPMENT OR EVALUATION PURPOSES ONLY** and is not provided by LTC for commercial use. As such, the DEMO BOARD herein may not be complete in terms of required design-, marketing-, and/or manufacturing-related protective considerations, including but not limited to product safety measures typically found in finished commercial goods. As a prototype, this product does not fall within the scope of the European Union directive on electromagnetic compatibility and therefore may or may not meet the technical requirements of the directive, or other regulations.

If this evaluation kit does not meet the specifications recited in the DEMO BOARD manual the kit may be returned within 30 days from the date of delivery for a full refund. **THE FOREGOING WARRANTY IS THE EXCLUSIVE WARRANTY MADE BY THE SELLER TO BUYER AND IS IN LIEU OF ALL OTHER WARRANTIES, EXPRESSED, IMPLIED, OR STATUTORY, INCLUDING ANY WARRANTY OF MERCHANTABILITY OR FITNESS FOR ANY PARTICULAR PURPOSE. EXCEPT TO THE EXTENT OF THIS INDEMNITY, NEITHER PARTY SHALL BE LIABLE TO THE OTHER FOR ANY INDIRECT, SPECIAL, INCIDENTAL, OR CONSEQUENTIAL DAMAGES.**

The user assumes all responsibility and liability for proper and safe handling of the goods. Further, the user releases LTC from all claims arising from the handling or use of the goods. Due to the open construction of the product, it is the user's responsibility to take any and all appropriate precautions with regard to electrostatic discharge. Also be aware that the products herein may not be regulatory compliant or agency certified (FCC, UL, CE, etc.).

No License is granted under any patent right or other intellectual property whatsoever. **LTC assumes no liability for applications assistance, customer product design, software performance, or infringement of patents or any other intellectual property rights of any kind.**

LTC currently services a variety of customers for products around the world, and therefore this transaction **is not exclusive**.

**Please read the DEMO BOARD manual prior to handling the product.** Persons handling this product must have electronics training and observe good laboratory practice standards. **Common sense is encouraged.**

This notice contains important safety information about temperatures and voltages. For further safety concerns, please contact a LTC application engineer.

Mailing Address:

Linear Technology  
1630 McCarthy Blvd.  
Milpitas, CA 95035

Copyright © 2004, Linear Technology Corporation

dc1181bf



Linear Technology Corporation  
1630 McCarthy Blvd., Milpitas, CA 95035-7417  
(408) 432-1900 • FAX: (408) 434-0507 • www.linear.com

LT 0909 • PRINTED IN USA



© LINEAR TECHNOLOGY CORPORATION 2009