

LT8640S

42V, 6A Micropower Synchronous Step-Down Silent Switcher 2

DESCRIPTION

Demonstration circuit 2530A is a 42V, 6A micropower synchronous step-down second generation Silent Switcher[®] with spread spectrum frequency modulation featuring the **LT8640S**. The demo board is designed for 5V output from a 5.8V to 42V input. The wide input range allows a variety of input sources, such as automotive batteries and industrial supplies. The LT8640S is a compact, ultralow emission, high efficiency, and high speed synchronous monolithic step-down switching regulator. The integrated bypass capacitors optimize all the fast current loops and make it easier to minimize EMI/EMC emissions by reducing layout sensitivity. Selectable spread spectrum mode can further improve EMI/EMC performance. Ultralow quiescent current in Burst Mode[®] operation achieves high efficiency at very light loads. Fast minimum on-time of 30ns enables high V_{IN} to low V_{OUT} conversion at high frequency.

The LT8640S switching frequency can be programmed either via oscillator resistor or external clock over a 200kHz to 3MHz range. The default frequency of demo circuit 2530A is 2MHz. The SYNC pin on the demo board is grounded (JP1 at BURST position) by default for low ripple Burst Mode operation. To synchronize to an external clock, move JP1 to SYNC and apply the external clock to the SYNC terminal. Spread spectrum mode and forced continuous mode can be selected respectively by moving JP1 shunt. Figure 1 shows the efficiency of the circuit at 12V input and 24V input in Burst Mode Operation (input from VIN terminal to bypass the EMI filter). Figure 2 shows

the LT8640S temperature rising on DC2530A demo board under different load conditions. The rated maximum load current is 6A, while derating is necessary for certain input voltage and thermal conditions.

The demo board has an EMI filter installed. The EMI performance of the board (with EMI filter) is shown on Figure 3. The red line in Radiated EMI Performance is CISPR25 Class 5 peak limit. The figure shows that the circuit passes the test with a wide margin. To achieve EMI/EMC performance as shown in Figure 3, the input EMI filter is required and the input voltage should be applied at VEMI terminal. An inductor can be added in the EMI filter to further reduce the conducted emission. The EMI filter can be bypassed by applying the input voltage at VIN terminal.

The LT8640S data sheet gives a complete description of the part, operation and application information. The data sheet must be read in conjunction with this demo manual for demo circuit 2530A. The LT8640S is assembled in a 4mm × 4mm LQFN package with exposed pads for low thermal resistance. The layout recommendations for low EMI operation and maximum thermal performance are available in the data sheet section Low EMI PCB Layout and Thermal Considerations and Peak Output Current.

Design files for this circuit board are available at <http://www.linear.com/demo/DC2530A>

LT, LT, LTC, LTM, Linear Technology, the Linear logo, Burst Mode and Silent Switcher are registered trademarks of Analog Devices, Inc. All other trademarks are the property of their respective owners.

PERFORMANCE SUMMARY Specifications are at $T_A = 25^\circ\text{C}$

SYMBOL	PARAMETER	CONDITIONS	MIN	TYP	MAX	UNITS
V_{IN_EMI}	Input Supply Range with EMI Filter		5.8		42	V
V_{OUT}	Output Voltage		4.85	5	5.15	V
I_{OUT}	Maximum Output Current	Derating is Necessary for Certain V_{IN} and Thermal Conditions	6			A
f_{SW}	Switching Frequency		1.85	2	2.15	MHz
EFF	Efficiency	$V_{IN} = 12\text{V}, I_{OUT} = 3\text{A}$		94.3		%

DESCRIPTION

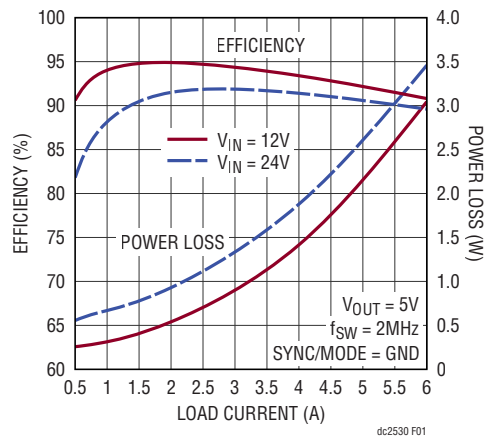

Figure 1. LT8640S Demo Circuit DC2530A Efficiency vs Load Current (Input from VIN Terminal)

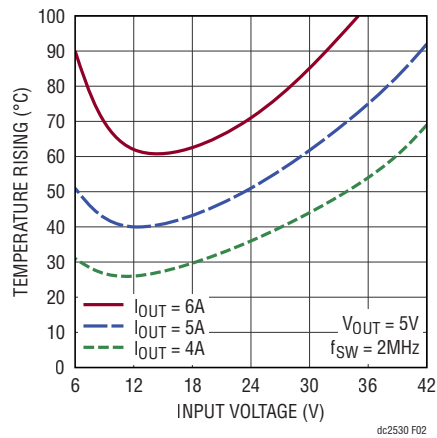
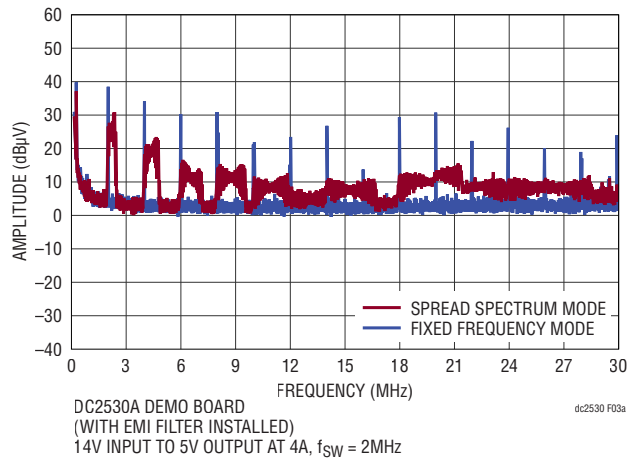

Figure 2. LT8640S Demo Circuit DC2530A Temperature Rising vs Input Voltage

DESCRIPTION

Conducted EMI Performance



Radiated EMI Performance
(CISPR25 Radiated Emission Test with Class 5 Peak Limits)

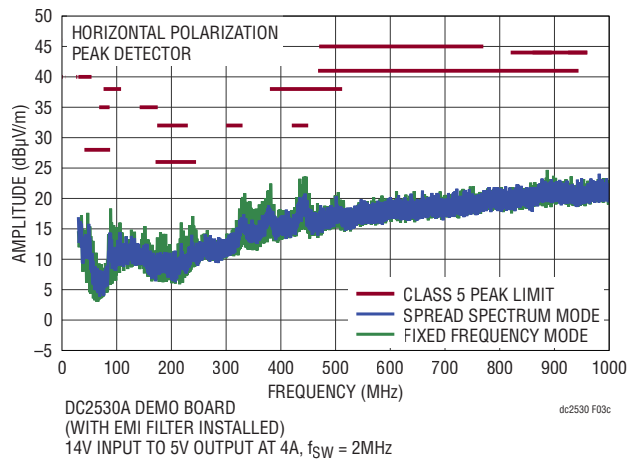
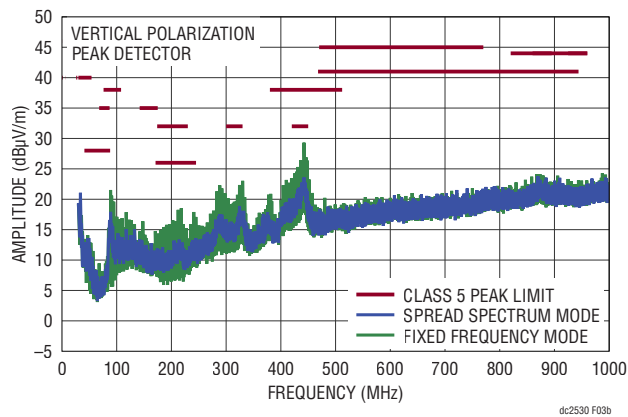

Figure 3. LT8640S Demo Circuit DC2530A EMI Performance (14V input from VEMI, with EMI filter, $I_{OUT} = 4A$)

QUICK START PROCEDURE

Demonstration circuit 2530A is easy to set up to evaluate the performance of the LT8640S. Refer to Figure 4 for proper measurement equipment setup and follow the procedure below:

NOTE: When measuring the input or output voltage ripple, care must be taken to avoid a long ground lead on the oscilloscope probe. Measure the output voltage ripple by touching the probe tip directly across the output capacitor. See Figure 5 for the proper scope technique. Figure 6 shows the output voltage ripple measured at the output capacitor C9.

1. Place JP1 on BURST position.
2. With power off, connect the input power supply to VEMI and GND. If the input EMI filter is not desired, connect the input power supply to VIN and GND.
3. With power off, connect the load from VOUT to GND.
4. Turn on the power at the input.

NOTE: Make sure that the input voltage does not exceed 42V.

5. Check for the proper output voltage ($V_{OUT} = 5V$).

NOTE: If there is no output, temporarily disconnect the load to make sure that the load is not set too high or is shorted.

6. Once the proper output voltage is established, adjust the load within the operating ranges and observe the output voltage regulation, ripple voltage, efficiency and other parameters.
7. An external clock can be added to the SYNC terminal when SYNC function is used (JP1 on the SYNC position). Please make sure that R2 should be chose to set the LT8640S switching frequency equal to or below the lowest SYNC frequency. JP1 can also set LT8640S in spread spectrum mode (JP1 on the SPREAD-SPECTRUM position) or forced continuous mode (JP1 on the FCM position).

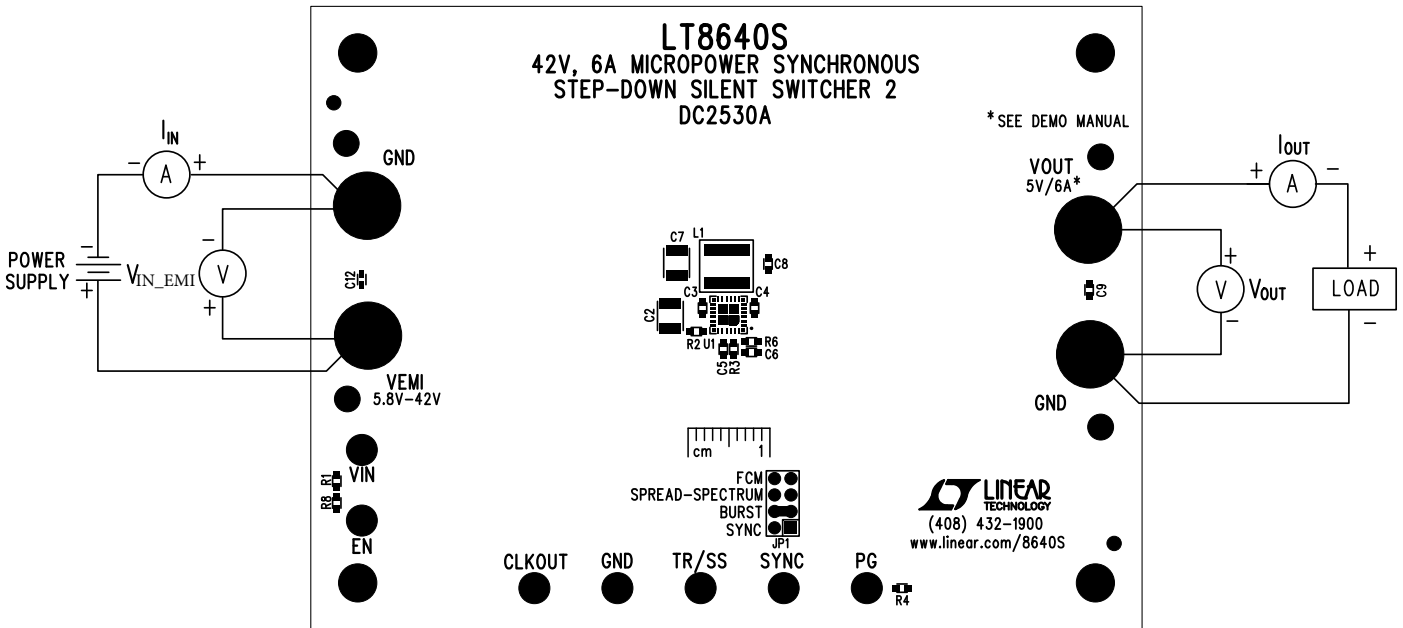

Figure 4. Proper Measurement Equipment Setup

QUICK START PROCEDURE

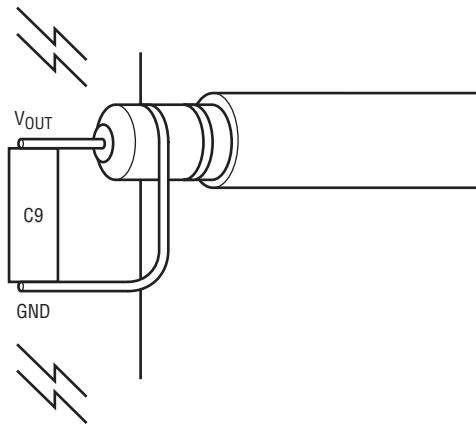

Figure 5. Measuring Output Ripple at Output Capacitor C9

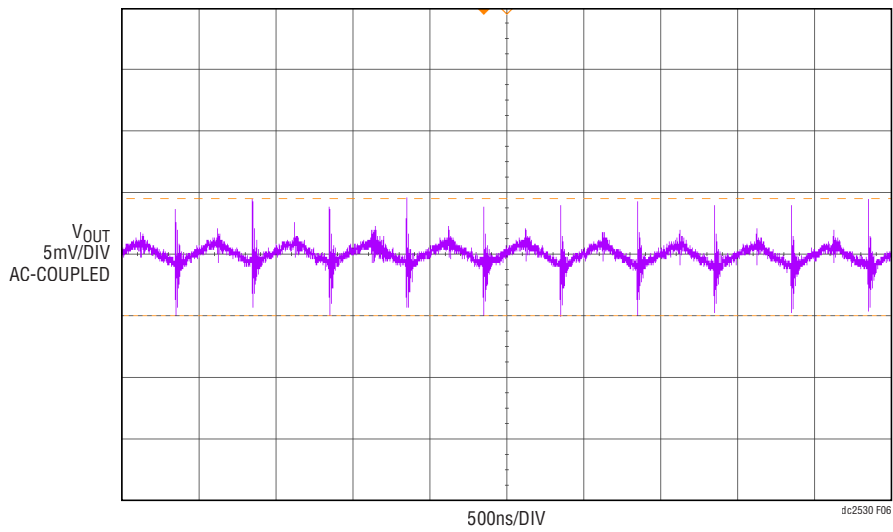

Figure 6. LT8640S Demo Circuit DC2530A Output Voltage Ripple (12V Input, $I_{OUT} = 6A$, Full BW)

DEMO MANUAL DC2530A

PARTS LIST

ITEM	QTY	REFERENCE	PART DESCRIPTION	MANUFACTURER/PART NUMBER
Required Circuit Components				
1	1	C2	CAP., X7R, 10 μ F, 50V, 10%, 1210	MURATA, GRM32ER71H106KA12L
2	2	C3, C4	CAP., X5R, 1 μ F, 50V, 10%, 0603	MURATA, GRM188R61H105KAALD
3	1	C5	CAP., X7R, 0.1 μ F, 16V, 10%, 0603	MURATA, GRM188R71C104KA01D
4	1	C6	CAP., NPO, 10pF, 50V, 5%, 0603	MURATA, GRM1885C1H100JA01D
5	1	C7	CAP., X5R, 100 μ F, 10V, 20% 1210	MURATA, GRM32ER61A107ME20L
6	1	C8	CAP., X7R, 1 μ F, 10V, 10%, 0603	MURATA, GRM188R71A105KA61D
7	1	C9	CAP., X5R, 10 μ F, 25V, 20%, 0603	MURATA, GRM188R61E106MA73D
8	1	L1	INDUCTOR, 1.5 μ H	COILCRAFT, XEL6030-152ME
9	2	R1, R4	RES., CHIP, 100k, 1/10W, 1% 0603	VISHAY, CRCW0603100KFKEA
10	1	R2	RES., CHIP, 17.8k, 1/10W, 1% 0603	VISHAY, CRCW060317K8FKEA
11	1	R3	RES., CHIP, 243k, 1/10W, 1%, 0603	VISHAY, CRCW0603243KFKEA
12	1	R6	RES., CHIP, 1M, 1/10W, 1%, 0603	VISHAY, CRCW06031M00FKEA
13	1	U1	I.C., STEP-DOWN SWITCHER, 4MMx4MM LQFN	LINEAR TECH., LT8640SEV#PBF
Additional Demo Board Circuit Components				
1	1	C1	CAP., ALUM 22 μ F, 63V	SUN ELECT., 63CE22BS
2	2	C10, C11	CAP., X7R, 10 μ F, 50V, 10%, 1210	MURATA, GRM32ER71H106KA12L
3	2	C12, C13	CAP., X7R, 0.1 μ F, 50V, 10%, 0402	MURATA, GRM155R71H104KE14D
4	0	C14 (OPT)	CAP., OPTION, 0603	
5	1	FB1	BEAD, FERRITE, 100 Ω , 1812	WURTH ELEKTRONIK, 74279226101
6	1	R7	RES., CHIP, 0 Ω , 1/10W, 1%, 0603	VISHAY, CRCW06030000Z0EA
7	0	R8 (OPT)	RES., OPTION, 0603	
Hardware: For Demo Board Only				
1	7	E1, E4-E8, E10	TESTPOINT, TURRET, 0.094"	MILL-MAX, 2501-2-00-80-00-00-07-0
2	4	E2, E9, E11, E12	TESTPOINT, TURRET, 0.061"	MILL-MAX, 2308-2-00-80-00-00-07-0
3	1	JP1	2X4, 0.079 DOUBLE ROW HEADER	WURTH ELEKTRONIK, 62000821121
4	1	XJP1	SHUNT, 0.079" CENTER	WURTH ELEKTRONIK, 60800213421
5	4	J1-J4	JACK BANANA	KEYSTONE, 575-4
6	4	MH1-MH4	STAND-OFF, NYLON 0.50" TALL	WURTH ELEKTRONIK, 702935000

SCHEMATIC DIAGRAM

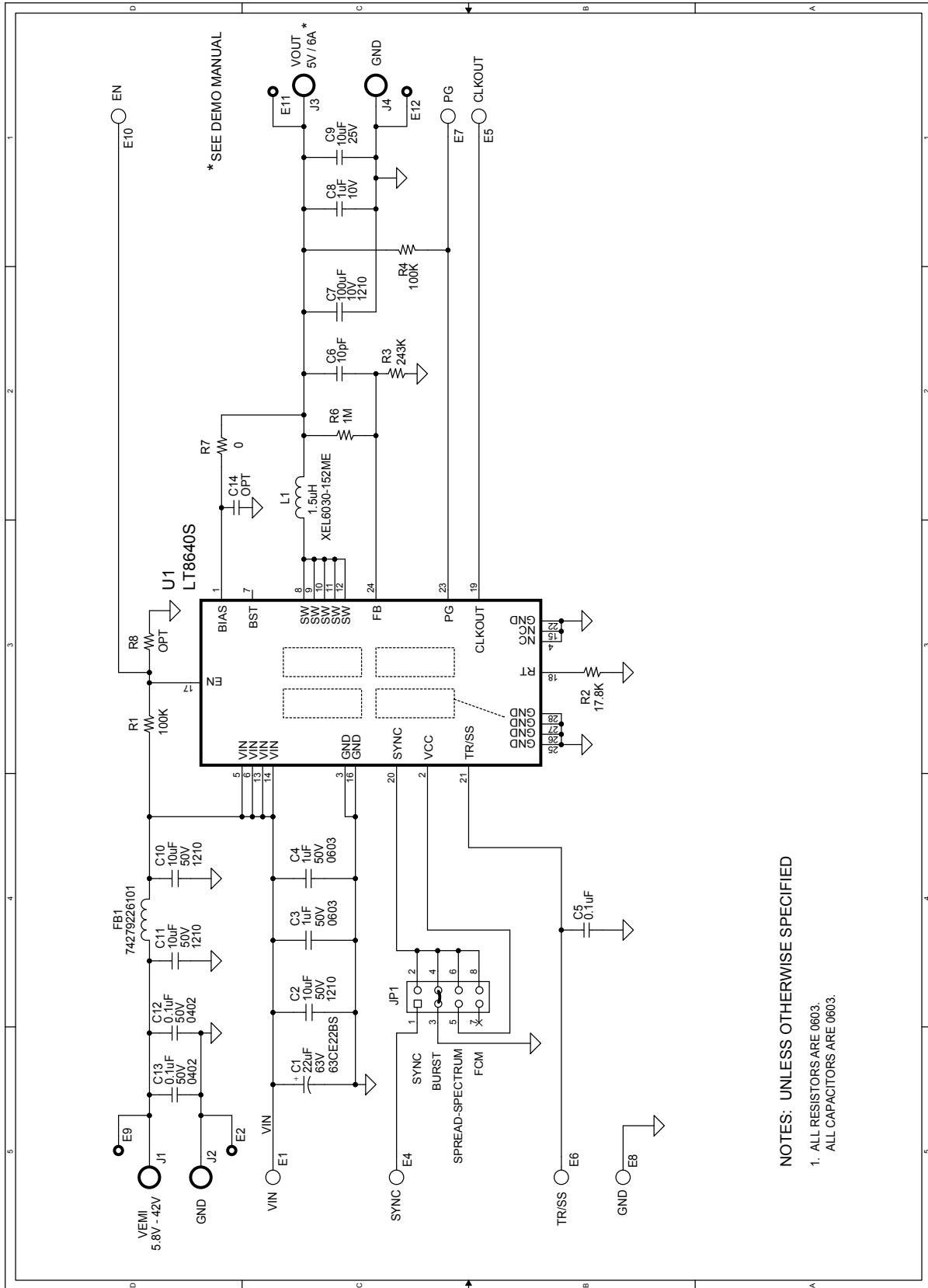

NOTES: UNLESS OTHERWISE SPECIFIED

- 1. ALL RESISTORS ARE 0603.
- ALL CAPACITORS ARE 0603.

DEMO MANUAL DC2530A

DEMONSTRATION BOARD IMPORTANT NOTICE

Linear Technology Corporation (LTC) provides the enclosed product(s) under the following **AS IS** conditions:

This demonstration board (DEMO BOARD) kit being sold or provided by Linear Technology is intended for use for **ENGINEERING DEVELOPMENT OR EVALUATION PURPOSES ONLY** and is not provided by LTC for commercial use. As such, the DEMO BOARD herein may not be complete in terms of required design-, marketing-, and/or manufacturing-related protective considerations, including but not limited to product safety measures typically found in finished commercial goods. As a prototype, this product does not fall within the scope of the European Union directive on electromagnetic compatibility and therefore may or may not meet the technical requirements of the directive, or other regulations.

If this evaluation kit does not meet the specifications recited in the DEMO BOARD manual the kit may be returned within 30 days from the date of delivery for a full refund. **THE FOREGOING WARRANTY IS THE EXCLUSIVE WARRANTY MADE BY THE SELLER TO BUYER AND IS IN LIEU OF ALL OTHER WARRANTIES, EXPRESSED, IMPLIED, OR STATUTORY, INCLUDING ANY WARRANTY OF MERCHANTABILITY OR FITNESS FOR ANY PARTICULAR PURPOSE. EXCEPT TO THE EXTENT OF THIS INDEMNITY, NEITHER PARTY SHALL BE LIABLE TO THE OTHER FOR ANY INDIRECT, SPECIAL, INCIDENTAL, OR CONSEQUENTIAL DAMAGES.**

The user assumes all responsibility and liability for proper and safe handling of the goods. Further, the user releases LTC from all claims arising from the handling or use of the goods. Due to the open construction of the product, it is the user's responsibility to take any and all appropriate precautions with regard to electrostatic discharge. Also be aware that the products herein may not be regulatory compliant or agency certified (FCC, UL, CE, etc.).

No License is granted under any patent right or other intellectual property whatsoever. **LTC assumes no liability for applications assistance, customer product design, software performance, or infringement of patents or any other intellectual property rights of any kind.**

LTC currently services a variety of customers for products around the world, and therefore this transaction **is not exclusive**.

Please read the DEMO BOARD manual prior to handling the product. Persons handling this product must have electronics training and observe good laboratory practice standards. **Common sense is encouraged.**

This notice contains important safety information about temperatures and voltages. For further safety concerns, please contact a LTC application engineer.

Mailing Address:

Linear Technology
1630 McCarthy Blvd.
Milpitas, CA 95035

Copyright © 2004, Linear Technology Corporation