

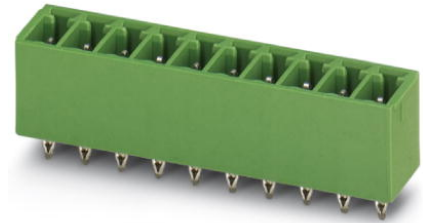

EMCV 1,5/ 2-G-3,5

Order No.: 1911017

The figure shows a 10-position version of the product

<http://eshop.phoenixcontact.de/phoenix/treeViewClick.do?UID=1911017>

Header, Nominal current: 8 A, Rated voltage (III/2): 160 V, Number of positions: 2, Pitch: 3.5 mm, Color: green, Metal surface: Sn, Assembly: Press-in

Commercial data	
GTIN (EAN)	 4 017918 175764
sales group	E105
Pack	50 pcs.
Customs tariff	85366990
Catalog page information	Page 173 (CC-2009)

Product notesWEEE/RoHS-compliant since:
01/01/2003

<http://www.download.phoenixcontact.com>
Please note that the data given here has been taken from the online catalog. For comprehensive information and data, please refer to the user documentation. The General Terms and Conditions of Use apply to Internet downloads.

Technical data	
Dimensions / positions	
Length	7.25 mm
Pitch	3.5 mm
Dimension a	3.5 mm
Number of positions	2

Pin dimensions	0,8 x 0,8 mm
Hole diameter	1.45 mm

Technical data

Range of articles	EMCV 1,5/...-G
Insulating material group	IIIa
Rated surge voltage (III/3)	2.5 kV
Rated surge voltage (III/2)	2.5 kV
Rated surge voltage (II/2)	2.5 kV
Rated voltage (III/2)	160 V
Rated voltage (II/2)	250 V
Connection in acc. with standard	EN-VDE
Nominal current I_N	8 A
Nominal voltage U_N	160 V
Maximum load current	8 A
Insulating material	PBT
Inflammability class acc. to UL 94	V0
Nominal voltage, UL/CUL Use Group B	300 V
Nominal current, UL/CUL Use Group B	8 A
Nominal voltage, UL/CUL Use Group D	300 V
Nominal current, UL/CUL Use Group D	8 A

Certificates / Approvals



Certification

CUL, GOST, UL

Accessories

Item	Designation	Description
Assembly		
1877258	EMC 1,5-SH	Stamp holder, for upper and lower stamp
1877274	EMCV 1,5-SS 1	Stamp set, consisting of upper and lower stamp for 3.81 mm pitch, 2 to 16-pos.

Marking

0804073	SK 3,5/2,8:FORTL.ZAHLEN	Marker card, printed horizontally, self-adhesive, 10-section marker strip, 14 identical decades marked 1-10, 11-20 etc. up to 91-100, sufficient for 140 terminal blocks
---------	-------------------------	--

Plug/Adapter

1734634	CP-MSTB	Keying profile, is inserted into the slot on the plug or inverted header, red insulating material
---------	---------	---

Additional products

Item	Designation	Description
General		
1840366	MC 1,5/ 2-ST-3,5	Plug component, Nominal current: 8 A, Rated voltage (III/2): 160 V, Number of positions: 2, Pitch: 3.5 mm, Color: green, Metal surface: Sn
1863152	MCVR 1,5/ 2-ST-3,5	Plug component, Nominal current: 8 A, Rated voltage (III/2): 160 V, Number of positions: 2, Pitch: 3.5 mm, Color: green, Metal surface: Sn
1862852	MCVW 1,5/ 2-ST-3,5	Plug component, Nominal current: 8 A, Rated voltage (III/2): 160 V, Number of positions: 2, Pitch: 3.5 mm, Color: green, Metal surface: Sn

Diagrams/Drawings

Drilling plan/solder pad geometry

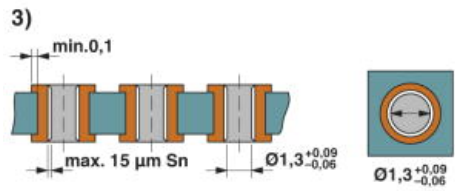
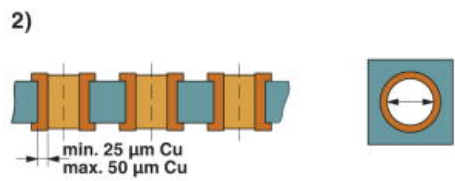
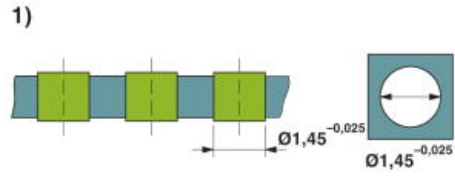
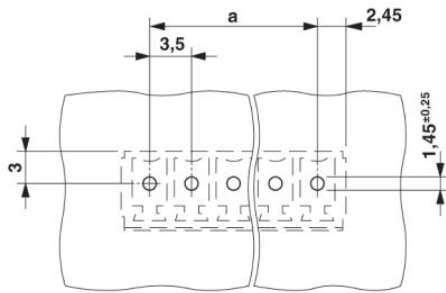

Drill hole layout in FR4 or EP-GC basic material

Dimensioned drawing

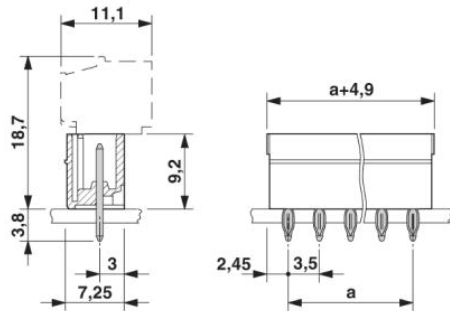

Address

PHOENIX CONTACT Deutschland GmbH
Flachmarktstr. 8
32825 Blomberg, Germany
Phone +49 5235 3 12000
Fax +49 5235 3 41200
<http://www.phoenixcontact.de>



© 2010 Phoenix Contact
Technical modifications reserved;