

## Key Features of GYPRO®-EVB2

- Printed Circuit Board for evaluation of GYPRO® products
- Includes 1 gyroscope and external passive components
- Plug and Play SPI interface, compatible with Arduino M0
- RS422 and USB interface for Arduino boards
- 3.3V and 5V power supply
- 3.3V and 5V compatibility for communication interface

## Key features of GYPRO® MEMS gyroscopes

- Angular rate measurement around Z-axis (yaw sensor)
- Digital 24-bit SPI output
- Excellent bias instability of 0.8 °/h (Allan variance at room temperature)
- Ultra-low RMS noise of < 0.05°/s over [1Hz -100Hz]



## 1. General Description

GYPRO®-EVB2 breakout board is intended to easily and quickly perform characterizations of GYPRO2300, GYPRO2300LD and GYPRO3300 gyroscopes with the Tronics Evaluation Tool. GYPRO®-EVB2 was specially designed to be interfaced with an Arduino M0 board. The combination of GYPRO®-EVB2 with the Arduino platform is ideally suited for tests with rate table over the temperature range [-40°C to +85°C].

The 3.3V and 5V compatibility for SPI communication also enables connecting the GYPRO®-EVB2 with most of the acquisition systems and microcontrollers in the market.

This document describes the mechanical and electrical features of the GYPRO®-EVB2 board as well as the SPI protocol used for the digital communication. This document is applicable for the whole GYPRO® product line, including GYPRO2300, GYPRO2300LD and GYPRO3300 gyros.

For more information about performances of each product, please refer to the dedicated datasheet, available on our [website](#).

## 2. Mechanical features

The evaluation board has the following dimensions:

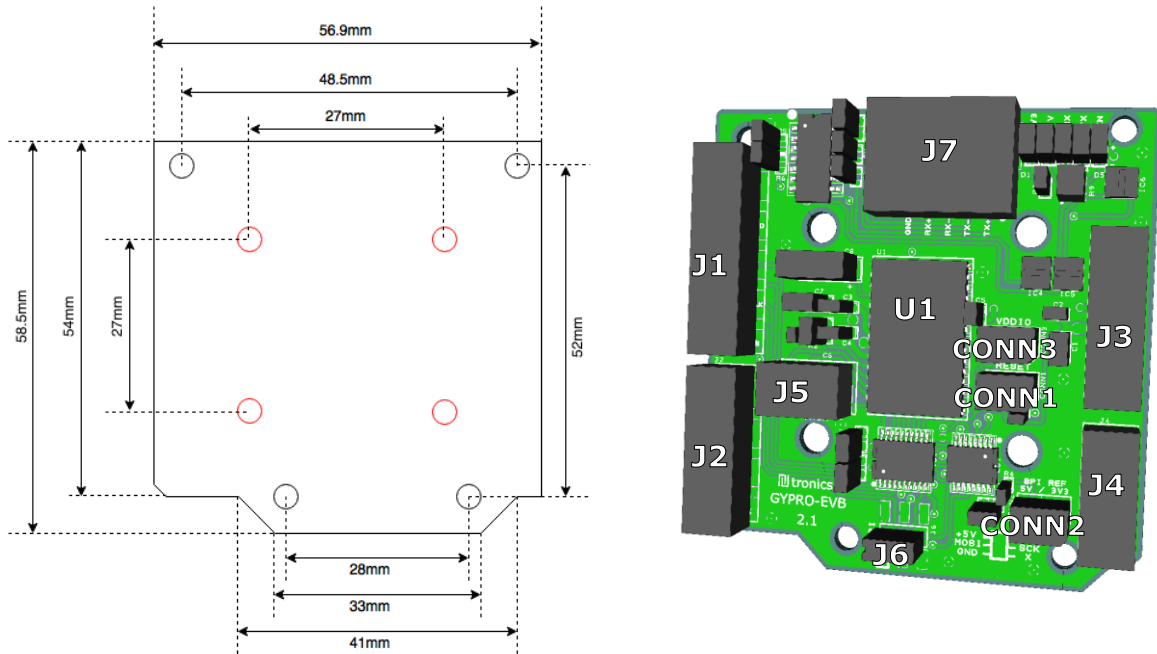

Figure 1: GYPRO®-EVB2 board (unpopulated) dimensions in millimeters with 3Dtop view

The main GYPRO®-EVB2 components are described in the table 1:

Name	Description	Information
CONN1	I/O connector	Sensor reset: <ul style="list-style-type: none"> <li>Without jumper: no reset</li> <li>With jumper: reset</li> </ul>
CONN2	I/O connector	SPI level voltage reference: <ul style="list-style-type: none"> <li>Without jumper: SPI level = +3.3V</li> <li>With jumper: SPI level = +5V</li> </ul>
CONN3	I/O connector	Not used
J1	I/O connector	GYPRO® I/O signals <ul style="list-style-type: none"> <li>Self-Test pin: ST</li> <li>Enable pin: EN</li> <li>Internal clock: FCLK</li> <li>SPI Chip select: SSB</li> </ul>
J2	I/O connector	Arduino UART signals (RX and TX)
J3	I/O connector	Power supply: +5V, +3.3V, GND
J4	I/O connector	Not used
J5	I/O connector	Tronics reserved
J6	I/O connector	Power supply lines: 5V, GND SPI lines: MOSI, MISO, SCLK
J7	I/O connector	RS422 connector (RX+, RX-, TX+, TX-, GND)
U1	GYPRO®	Angular rate sensor

Table 1: Main components description

Please note that the PCB has a flat backside and thickness of 1.6 mm. The board has been designed for a direct mounting onto the surface of your test equipment (rate table, vibration shaker...) in order to avoid parasitic mechanical resonance of the PCB.

### 3. Pins configuration and description

To enable compatibility with the Arduino M0 platform, some signals are redundant, such as 5V and GND signals. If you don't intend to use the Arduino platform, redundancy is not necessary. However the pins marked with bold characters in the tables below must absolutely be connected.

J1 gives access to the following signals:

Pin #	Name	Type	Function
#1	-	-	Not Connected
#2	-	-	Not Connected
#3	-	-	Not Connected
#4	GND	Power	Ground Power Supply
#5	-	-	Not Connected
#6	<b>ST</b>	<b>Output</b>	<b>Self-test pin</b>
#7	<b>EN</b>	<b>Input</b>	<b>Enable pin</b>
#8	<b>FCLK</b>	<b>Output</b>	<b>Internal clock</b>
#9	VDDIO	Input	Tronics Reserved
#10	<b>SSB</b>	<b>Input</b>	<b>SPI Slave Select pin</b>

J2 gives access to the following signals:

Pin #	Name	Type	Function
#1	RX	Input	Arduino UART RX
#2	TX	Output	Arduino UART TX
#3	-	-	Not Connected
#4	-	-	Not Connected
#5	-	-	Not Connected
#6	-	-	Not Connected
#7	-	-	Not Connected
#8	-	-	Not Connected

J3 gives access to the following signals:

Pin #	Name	Type	Function
#1	-	-	Not Connected
#2	-	-	Not Connected
#3	-	-	Not Connected
#4	<b>3V3</b>	<b>Power</b>	<b>3.3V Power Supply</b>
#5	<b>5V</b>	<b>Power</b>	<b>5V Power Supply</b>
#6	<b>GND</b>	<b>Power</b>	<b>Ground Power Supply</b>
#7	GND	Power	Ground Power Supply
#8	-	-	Not Connected

J4 gives access to the following signals:

Pin #	Name	Type	Function
#1	-	-	Not Connected
#2	-	-	Not Connected
#3	-	-	Not Connected
#4	-	-	Not Connected
#5	-	-	Not Connected
#6	-	-	Not Connected

J5 gives access to the following signals:

Pin #	Name	Type	Function
#1	T0	Output	Tronics Reserved
#2	T1	Output	Tronics Reserved
#3	T2	Output	Tronics Reserved
#4	T3	Output	Tronics Reserved

J6 gives access to the following signals:

Pin #	Name	Type	Function
#1	5V	Power	5V Power Supply
#2	<b>MOSI</b>	<b>Input</b>	<b>SPI data input</b>
#3	GND	Power	Ground Power Supply
#4	<b>MISO</b>	<b>Output</b>	<b>SPI data output</b>
#5	<b>SCLK</b>	<b>Input</b>	<b>SPI serial clock</b>
#6	-	-	Not Connected

J7 gives access to the following signals:

Pin #	Name	Type	Function
#1	TX+	Output	Arduino RS422 TX+
#2	TX-	Output	Arduino RS422 TX-
#3	RX-	Input	Arduino RS422 RX-
#4	RX+	Input	Arduino RS422 RX+
#5	GND	Power	Ground Power Supply

For more information about the RS422 interface and its use, please refer to the dedicated technical notes, available on our [website](#)

## 4. Electrical circuit

The following figure presents the electrical schematic of the board with its passive components (resistors & capacitances).

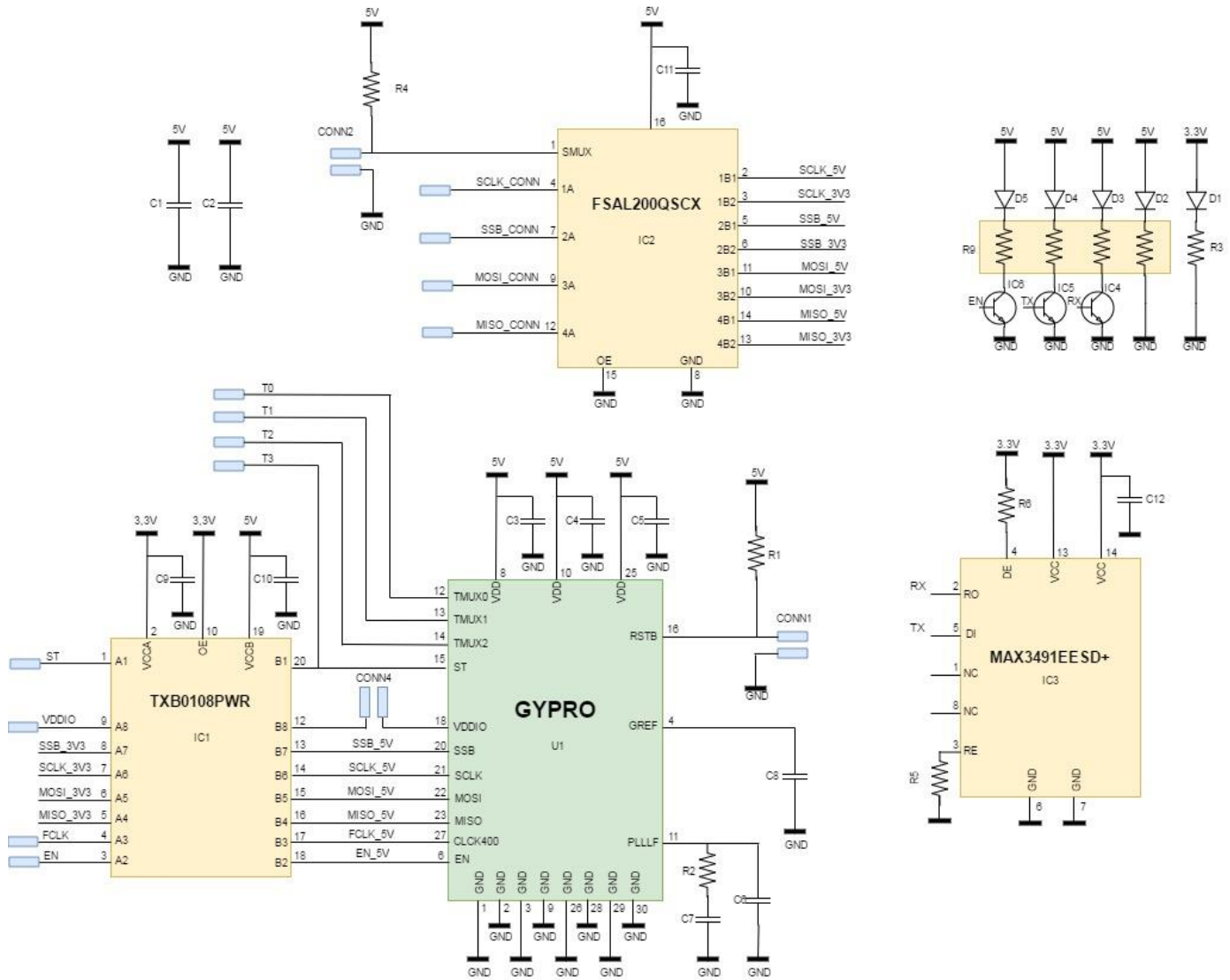

Figure 2: Electrical schematic

## 5. Electrical Characteristics

Parameter	Min	Typical	Max	Units
5V Power Supply	4.75	5	5.25	V
3.3V Power Supply	3.05	3.3	3.55	V
Current consumption <sup>1)</sup>		25		mA
Output		Digital 24 bits		-
Digital interface		SPI		-

1) The specified value represents the typical current consumption of GYPRO® products.

**Table 2: Electrical characteristics**

For compatibility with multiple acquisition devices (e.g. microcontrollers), a 3.3V level shifter (TXB0108PWR), paired with a demultiplexer switch (FSAL200QSCX), has been implemented on the board. The user can choose a 3.3V or a 5V logic voltage level on the SPI, by connecting or disconnecting a jumper on the CONN3 connector.

**If you would like to operate with a 3.3V logic voltage level, it is mandatory to power the board with both 3.3V AND 5V. To operate with a 5V logic voltage level, you can supply only the 5V power supply.**

For more information about advanced use of GYPRO® product, please refer to the dedicated GYPRO® datasheet, available on our [website](#)

### Caution!



The product may be damaged by ESD, which can cause performance degradation or device failure! We recommend handling the device only on a static safe work station. Precaution for the storage should also be taken.

The sensor **MUST** be powered-on *before* any SPI operation. Having the SPI pads at a high level while VDD is at 0V could damage the sensor, due to ESD protection diodes and buffers.





















## 6. Environment

Environmental specifications for GYPRO® gyroscopes and GYPRO®-EVB are the following:

Parameter	Condition	Min	Typ	Max	Units
Operating temperature range		-40		+85	°C
Humidity	At 45°C			98	%

**Table 3: Environmental specifications**

## 7. Available Tools and Resources

Item	Description	Link
<b>GYPRO® Datasheet</b>		
	<b>GYPRO2300 datasheet</b>	
	<b>GYPRO2300LD datasheet</b>	
	<b>GYPRO3300 datasheet</b>	
<b>Evaluation kit</b>		
	<b>GYPRO3300-EVB2 – Evaluation board</b> Evaluation board for GYPRO3300, compatible with Arduino M0	
	<b>GYPRO® Evaluation Board – User manual</b>	
	<b>GYPRO® Evaluation Kit – quick start guide</b>	
	<b>GYPRO® Evaluation Tool – software user manual</b>	
	<b>GYPRO® Evaluation Tool – Tutorial</b> Installation and programming of the Evaluation kit	
	<b>GYPRO® Evaluation Tool – Tutorial</b> Software	
	<b>GYPRO® Evaluation Tool – Software</b>	
	<b>GYPRO® Evaluation Tool – Arduino Firmware</b>	