



Description

The XR46000 is a silicon N-channel enhanced power MOSFET. With low conduction loss, good switching performance and high avalanche energy, it is suitable for various power supply system, especially for AC step driving application for LED lighting.

The package type is SOT-223, which comply with the RoHS standard.

Key Parameters

V_{DSS}	600V
I_D	1.5A
$P_D (T_C = 25^\circ C)$	20W
$R_{DS,ON,typ}$	7.0 Ω

FEATURES

- Fast switching
- ESD improved capability
- Low gate charge (Typ. 7.5nC)
- Low reverse transfer capacitance (Typ. 5.0pF)

APPLICATIONS

- LED lighting applications
 - Downlight
 - High bay
 - Specialty
 - Architectural

Equivalent Circuit

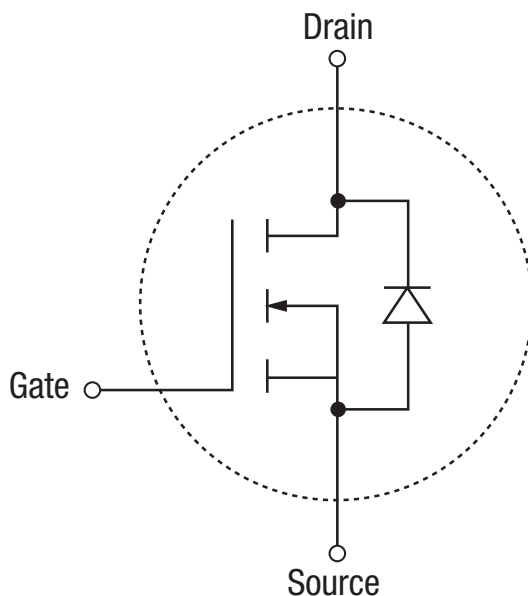
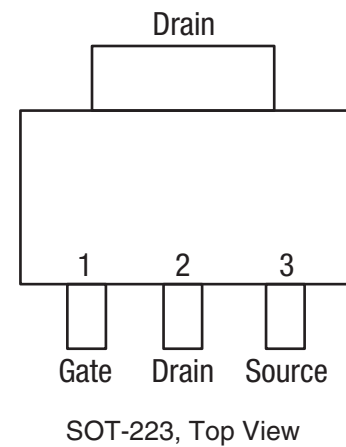

Figure 1. Equivalent Circuit

Pin Configuration



Absolute Maximum Ratings

Stresses beyond the limits listed below may cause permanent damage to the device. Exposure to any Absolute Maximum Rating condition for extended periods may affect device reliability and lifetime.

$T_C = 25^\circ\text{C}$ unless otherwise noted.

V_{DSS} drain-to-source voltage	600V
I_D continuous drain current ($T_C = 25^\circ\text{C}$)	1.5A
I_D continuous drain current ($T_C = 100^\circ\text{C}$)	0.85A
I_{DM} pulsed drain current	6A
V_{GS} gate-to-source voltage	$\pm 30\text{V}$
P_D power dissipation ($T_C = 25^\circ\text{C}$)	20W
P_D derating factor above 25°C	0.16W/ $^\circ\text{C}$
$T_{STORAGE}$ storage temperature range.....	-65°C to 150°C
E_{AS} single pulse avalanche energy	80mJ

NOTE:

Unless otherwise noted, all tests are pulsed tests at the specified temperature, therefore: $T_J = T_C = T_A$.

Operating Conditions

T_J operating junction temperature	150°C
T_A operating ambient temperature	-40°C to 85°C

Electrical Characteristics

$T_C = 25^\circ\text{C}$ unless otherwise noted.

Symbol	Parameter	Conditions	Min	Typ	Max	Units	
OFF Characteristic							
BV_{DSS}	Drain to source breakdown voltage	$V_{GS} = 0V, I_D = 250\mu A$	600			V	
$\Delta BV_{DSS}/\Delta T_J$	Breakdown voltage temperature coefficient	$I_D = 250\mu A$, reference 25°C		0.71		$V/^\circ\text{C}$	
I_{DSS}	Drain to source leakage current	$V_{DS} = 600V, V_{GS} = 0V, T_A = 25^\circ\text{C}$			25	μA	
		$V_{DS} = 600V, V_{GS} = 0V, T_A = 125^\circ\text{C}$			250		
$I_{GSS(F)}$	Gate to source forward leakage	$V_{GS} = 30V$			12	μA	
$I_{GSS(R)}$	Gate to source reverse leakage	$V_{GS} = -28V$			-12		
ON Characteristic (pulse width $t_p \leq 380\mu s, \delta \leq 2\%$)							
$R_{DS(ON)}$	Drain to source on-resistance	$V_{GS} = 10V, I_D = 0.75A$		7.0	8.0	Ω	
$V_{GS(TH)}$	Gate threshold voltage	$V_{DS} = V_{GS}, I_D = 250\mu A$	2.0		4.0	V	
Dynamic Characteristic							
g_{fs}	Forward transconductance	$V_{DS} = 15V, I_D = 0.75A$		1.0		s	
C_{iss}	Input capacitance	$V_{GS} = 0V, V_{DS} = 25V, f = 1\text{MHz}$		170		μF	
C_{oss}	Output capacitance			27			
C_{rss}	Reverse transfer capacitance			5			
Resistive Switching Characteristic							
$t_{d(ON)}$	Turn-on delay time	$I_D = 1.5A, V_{DD} = 300V, V_{GS} = 10V, R_G = 4.7\Omega$		8		ns	
t_r	Rise time			30			
$t_{d(OFF)}$	Turn-off delay time			22			
t_f	Fall time			55			
Q_g	Total gate charge	$I_D = 1.5A, V_{DD} = 480V, V_{GS} = 10V$		7.5		nC	
Q_{gs}	Gate to source charge			1.7			
Q_{gd}	Gate to drain "Miller" charge			4.0			
Source-Drain Diode Characteristics (pulse width $t_p \leq 380\mu s, \delta \leq 2\%$)							
I_S	Continuous source current (body diode)				1.5	A	
I_{SM}	Maximum source current (body diode)				6.0		
V_{SD}	Diode forward voltage	$I_S = 1.5A, V_{GS} = 0V$			1.5	V	
T_{rr}	Reverse recovery time	$I_D = 1.5A, T_J = 25^\circ\text{C}, dI_F/dt = 100A/\mu s, V_{GS} = 0V$		530		ns	
Q_{rr}	Reverse recovery charge				1100		nC
I_{RRM}	Reverse recovery current				4.4		A

Typical Performance Characteristics

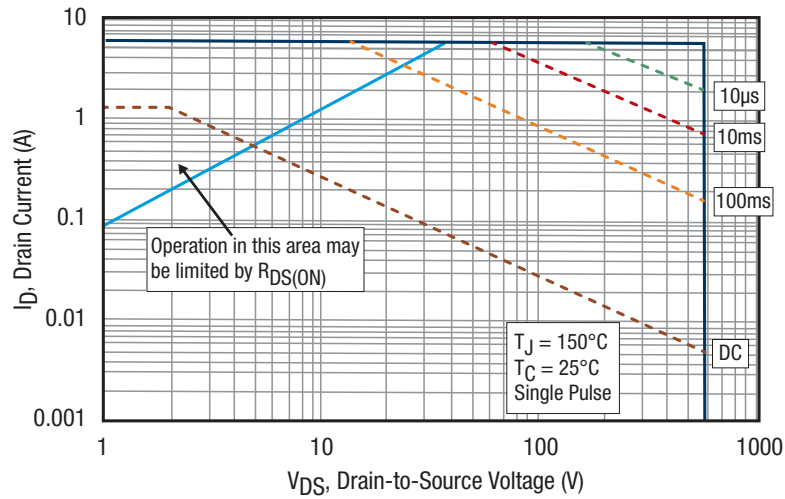

Figure 2. Safe Operating Area

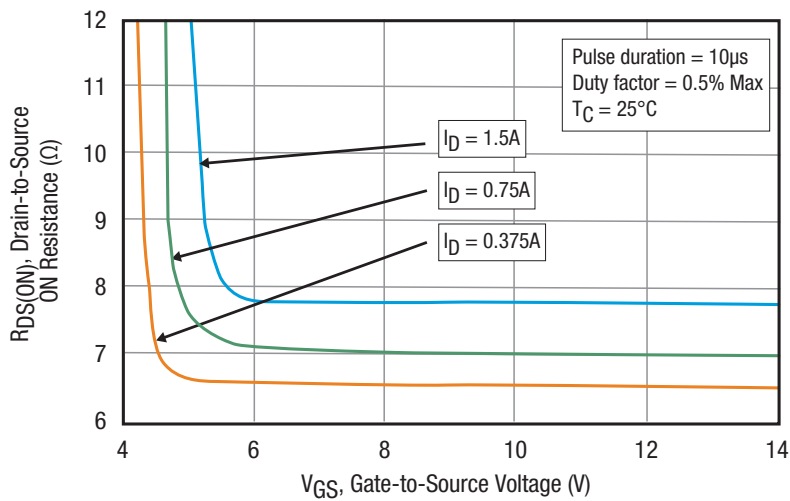

Figure 3. Typical Drain-to-Source ON Resistance vs. Gate Voltage and Drain Current

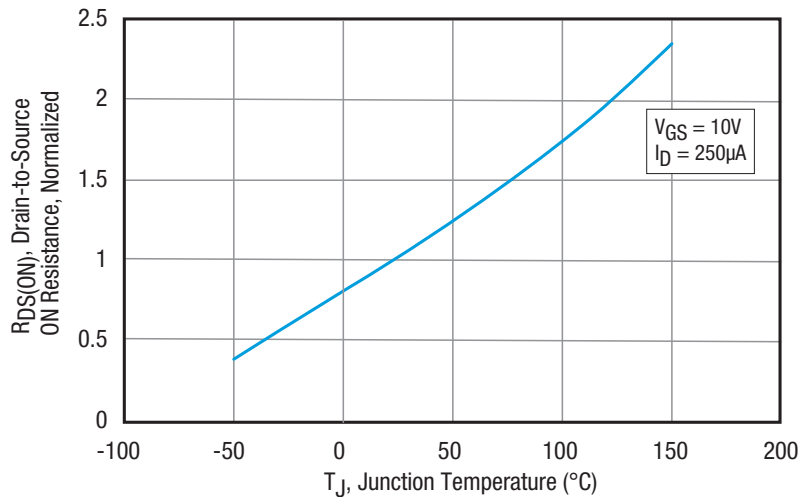
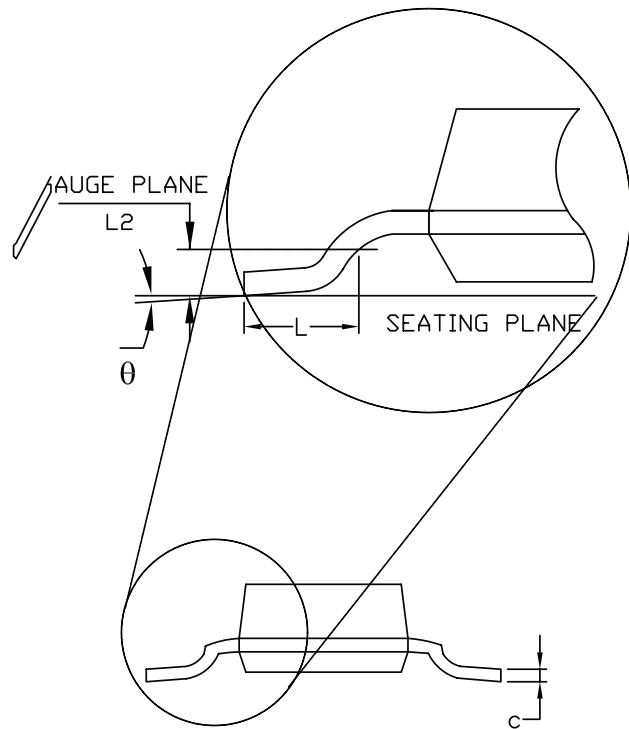
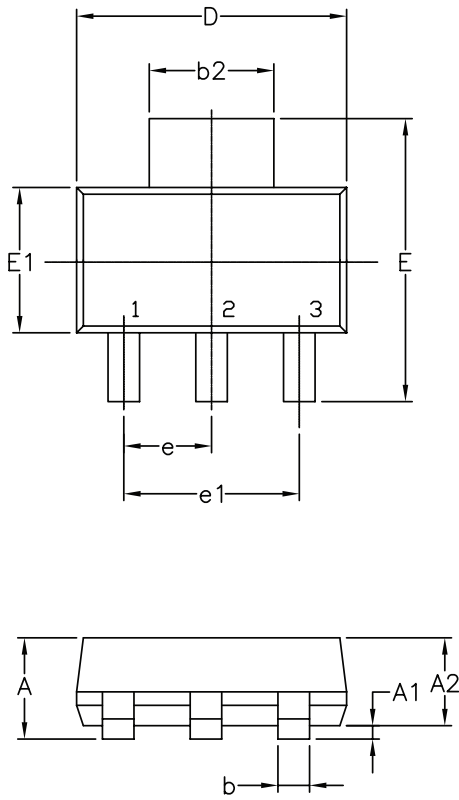

Figure 4. Typical Drain-to-Source ON Resistance vs. Junction Temperature

Package Description

Top View



Front View

Side View

3 Pin SOT-223 JEDEC TO-261 Variation AA						
SYMBOLS	DIMENSIONS IN MM (Control Unit)			DIMENSIONS IN INCH (Reference Unit)		
	MIN	NOM	MAX	MIN	NOM	MAX
A	—	—	1.80	—	—	0.071
A1	0.02	—	0.10	0.001	—	0.004
A2	1.50	1.60	1.70	0.060	0.063	0.067
b	0.66	0.76	0.84	0.026	0.030	0.033
b2	2.90	3.00	3.10	0.114	0.118	0.122
c	0.23	0.30	0.35	0.010	0.012	0.014
D	6.30	6.50	6.70	0.248	0.256	0.264
E	6.70	7.00	7.30	0.264	0.276	0.287
E1	3.30	3.50	3.70	0.130	0.138	0.146
e	2.30 BSC			0.091 BSC		
e1	4.60 BSC			0.182 BSC		
L	0.75	—	—	0.030	—	—
L2	0.25 BSC			0.010 BSC		
θ	0°	—	10°	0°	—	10°
N	3			3		

Ordering Information

Part Number	Operating Temperature Range	Environmental Rating	Package	Packaging Method
XR46000ESE	-40°C ≤ T _J ≤ 150°C	RoHS compliant and Green ⁽¹⁾	SOT-223	Bulk
XR46000ESETR			SOT-223	Tape and reel
XR46000ECF			Dice	Wafer

NOTE:

1. Visit www.exar.com for more information.

Revision History

Revision	Date	Description
1A	Aug 2016	Initial release



www.exar.com

48760 Kato Road
Fremont, CA 94538
USA

Tel.: +1 (510) 668-7000
Fax: +1 (510) 668-7001
Email: LEDtechsupport@exar.com

Exar Corporation reserves the right to make changes to the products contained in this publication in order to improve design, performance or reliability. Exar Corporation conveys no license under any patent or other right and makes no representation that the circuits are free of patent infringement. While the information in this publication has been carefully checked, no responsibility, however, is assumed for inaccuracies.

Exar Corporation does not recommend the use of any of its products in life support applications where the failure or malfunction of the product can reasonably be expected to cause failure of the life support system or to significantly affect its safety or effectiveness. Products are not authorized for use in such applications unless Exar Corporation receives, in writing, assurances to its satisfaction that: (a) the risk of injury or damage has been minimized; (b) the user assumes all such risks; (c) potential liability of Exar Corporation is adequately protected under the circumstances.

Reproduction, in part or whole, without the prior written consent of Exar Corporation is prohibited. Exar, XR and the XR logo are registered trademarks of Exar Corporation. All other trademarks are the property of their respective owners.