

MM 3D-MODEL: TM-111112-2410

## BASE CAGE DETAILS

(APPLIES TO ALL CAGES IN THIS DRAWING)

**747540410**  
SHOWN

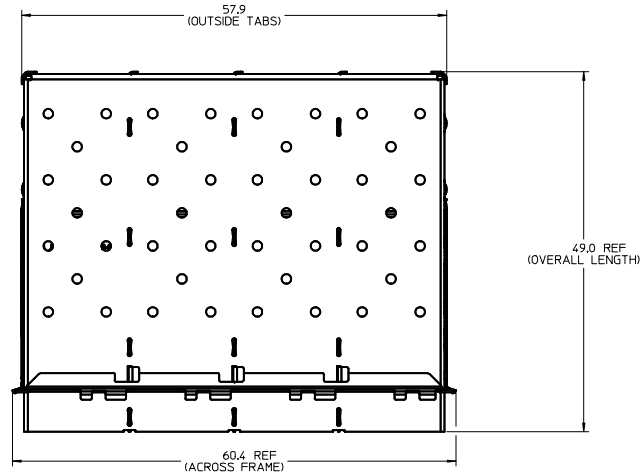

NOTE:  
EMI GASKET REMOVED FROM THIS VIEW FOR CLARITY.

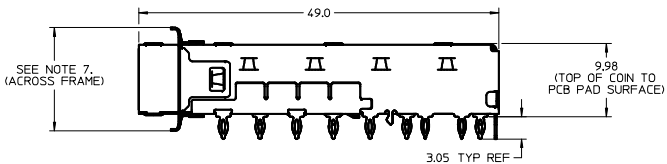
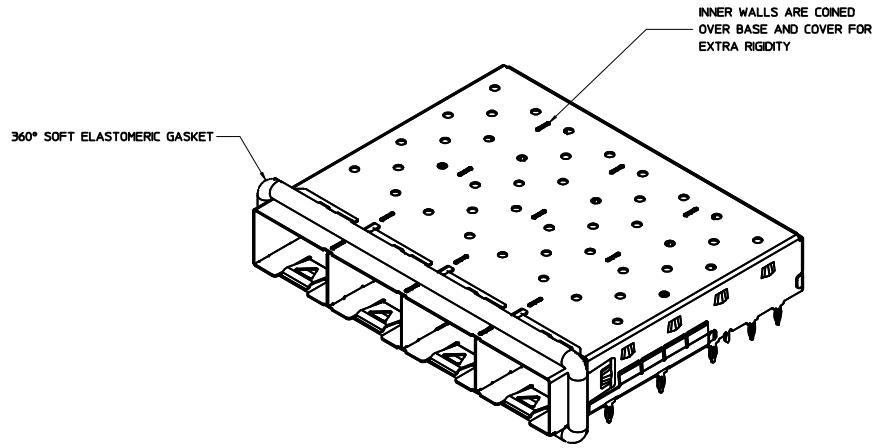
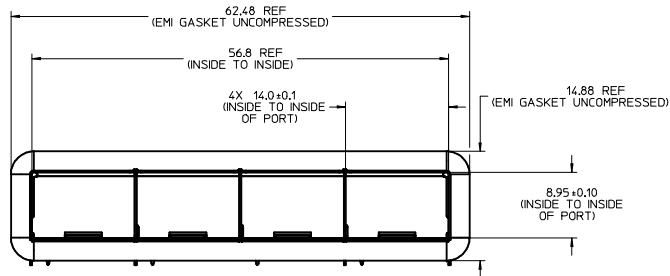

NOTE:  
EMI GASKET REMOVED FROM THIS VIEW FOR CLARITY.

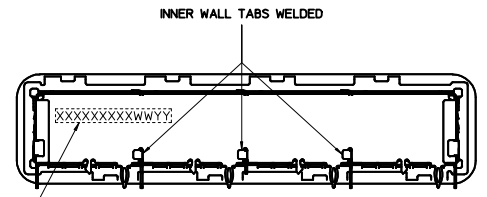

WEEK/YEAR DATE CODE TABLE	
WW	01 THRU 52 OR 53 EXAMPLE: 01 = FIRST WEEK OF YEAR 52 = LAST WEEK OF YEAR
YY	15, 16, 17 ETC. EXAMPLE: YEAR 2015 = 15

**NOTES:**

1. MATERIAL:  
 CAGE: 0.25mm THICK COPPER ALLOY, NICKEL PLATED.  
 SPRING FINGERS: 0.10mm THICK COPPER ALLOY, NICKEL PLATED.  
 HEATSINK: ALUMINUM, NICKEL PLATED.  
 HEATSINK SPRING CLIP: STAINLESS STEEL.
2. PRESS FIT LEGS 3.05mm (.120 INCH) LONG;
3. PORTS ARE DESIGNED FOR SFP+ TRANSCEIVERS AND ARE COMPATIBLE WITH SFP TRANSCEIVERS.  
 THE TOP SURFACE OF THE MODULE MUST BE FLAT (NO PRODUCT LABEL RECESS) AND THERMALLY CONDUCTIVE TO FUNCTION OPTIMALLY.
4. WELD SPOT MAY SHOW SLIGHT MATERIAL DISCOLORATION.
5. NO ROHS EXEMPTIONS.
6. CUSTOM HEATSINKS AVAILABLE UPON REQUEST.
7. MOST OF P/N ARE WITH 14.05 REF EXCEPT 747540415 & 747540419 ARE 12.55 REF.

SEE REVISION TABLE	QUALITY SYMBOLS	GENERAL TOLERANCES (UNLESS SPECIFIED)	DIMENSION STYLE	SCALE	DESIGN UNITS	THIRD ANGLE PROJECTION
EIC NO: CPG2016-2975 DRAWN BY: JHATTON CHYK: MCKERVEY APPR: KLLLOYD 2016/02/04 DESCRIPTION: SFP+ 1X4 CAGE, 3.05MM PRESS FIT, HEAT SINK, ELASTOMERIC GASKET	∇=0 ∇=0 ∇=0	mm    INCH 4 PLACES ± --- ± --- 3 PLACES ± --- ± --- 2 PLACES ± 0.13 ± --- 1 PLACE ± 0.25 ± --- 0 PLACE ± --- ± --- ANGULAR ± 1 ° DRAFT WHERE APPLICABLE MUST REMAIN WITHIN DIMENSIONS	MM ONLY DRAWN BY: JHATTON    DATE: 2012/12/03 CHECKED BY: MCKERVEY    DATE: 2012/12/07 APPROVED BY: KLLLOYD    DATE: 2012/12/20	3:1	METRIC	
			MATERIAL NO: SEE SHEET 3 DOCUMENT NO: SD-111112-2410	<b style="font-size: 12px;">molex</b>		
			SIZE: D	SHEET NO. 1 OF 9		

### CAGE ASSEMBLY OPTIONS

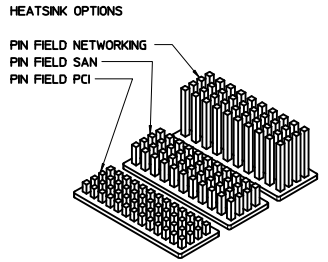
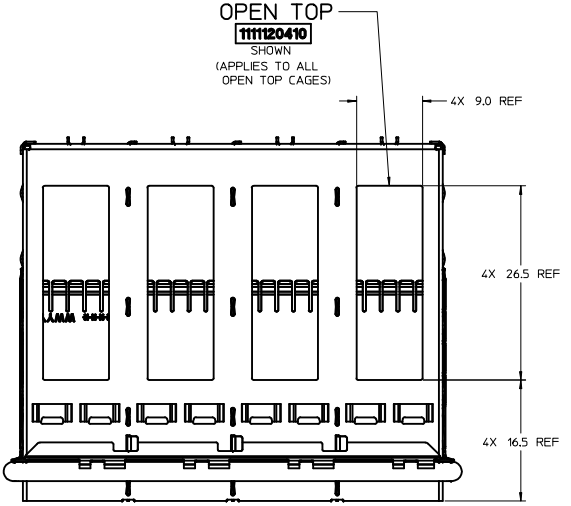

**OVERALL HEATSINK HEIGHT**

APPLICATION	DIM 'A'
PCI	14.3
SAN	16.6
NETWORKING	23.6

NOTE: PCI - 13 ROWS  
SAN - 11 ROWS  
NETWORKING - 10 ROWS

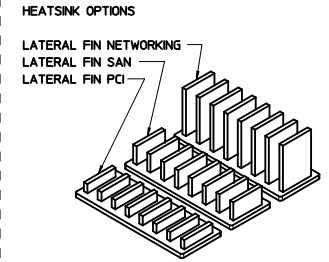

**OVERALL HEATSINK HEIGHT**

APPLICATION	DIM 'A'
PCI	14.3
SAN	16.6
NETWORKING	23.6

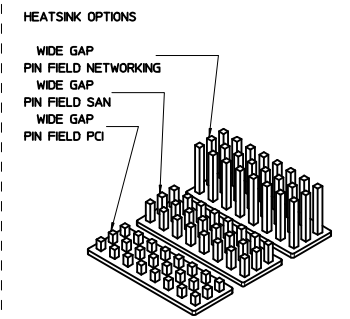

**OVERALL HEATSINK HEIGHT**

APPLICATION	DIM 'A'
PCI	14.3
SAN	16.6
NETWORKING	23.6

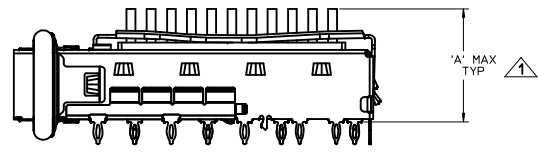

NOTES:  
▲ HEIGHT OF HEATSINK WITH MODULE INSERTED.  
DIMENSION MAY BE LESS DUE TO MODULE AND HEATSINK VARIATIONS.

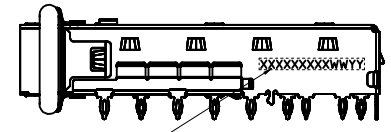
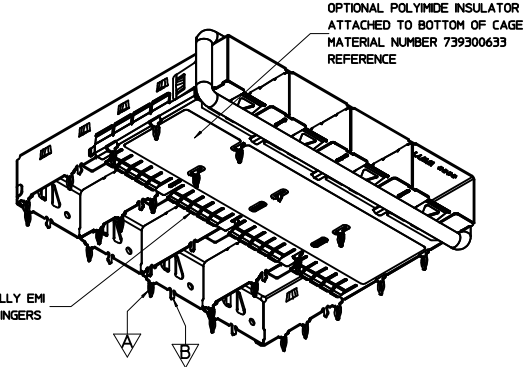

PART NO. AND WEEK/YEAR DATE CODE TO BE PRINTED ON BACK OF COMPLETED CAGE ASSEMBLY APPROXIMATELY AS SHOWN. SEE TABLE BELOW FOR DATE CODE INFORMATION.

**WEEK/YEAR DATE CODE TABLE**

WW	YY	EXAMPLE
01 THRU 52 OR 53	15, 16, 17 ETC.	01 = FIRST WEEK OF YEAR 52 = LAST WEEK OF YEAR

### REAR LEG OPTIONS (PER PORT)

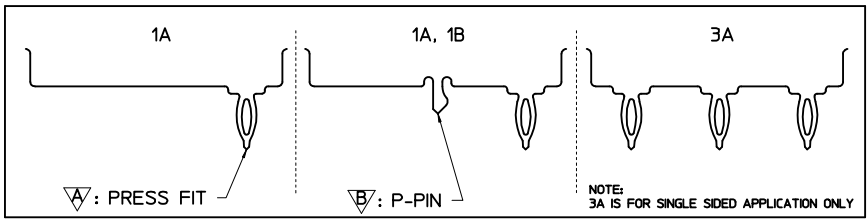

<b>SEE REVISION TABLE</b> EC NO: CPG2016-2975 CHKS: DRAWNACHENG03 APPROV: CHEN08 2016/02/04	QUALITY SYMBOLS ∇=0 ∇=0 ∇=0	GENERAL TOLERANCES (UNLESS SPECIFIED) 4 PLACES ± 0.13 3 PLACES ± 0.25 2 PLACES ± 0.25 1 PLACE ± 0.25 0 PLACE ± 0.25	DIMENSION STYLE MM ONLY SCALE 3:1 DESIGN UNITS METRIC THIRD ANGLE PROJECTION	DRAWN BY: JHATTON DATE: 2012/12/03 CHECKED BY: MCKERVEY DATE: 2012/12/07 APPROVED BY: KLOYD DATE: 2012/12/20	TITLE: SFP+ 1X4 CAGE, 3.05MM PRESS FIT, HEAT SINK, ELASTOMERIC GASKET MATERIAL NO. SD-11112-2410 DOCUMENT NO. SD-11112-2410	SHEET NO. 2 OF 9
	DRAFT WHERE APPLICABLE MUST REMAIN WITHIN DIMENSIONS		SEE SHEET 3	THIS DRAWING CONTAINS INFORMATION THAT IS PROPRIETARY TO MOLEX INCORPORATED AND SHOULD NOT BE USED WITHOUT WRITTEN PERMISSION		
	ANGULAR ± 1°					

OPTIONAL GEN 2 UNDER BELLY GASKET

100114-0410

SHOWN

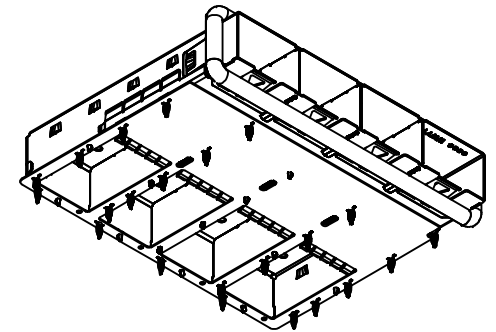
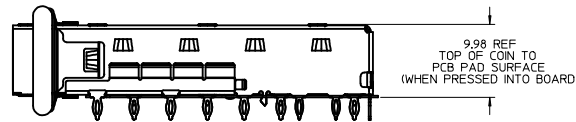
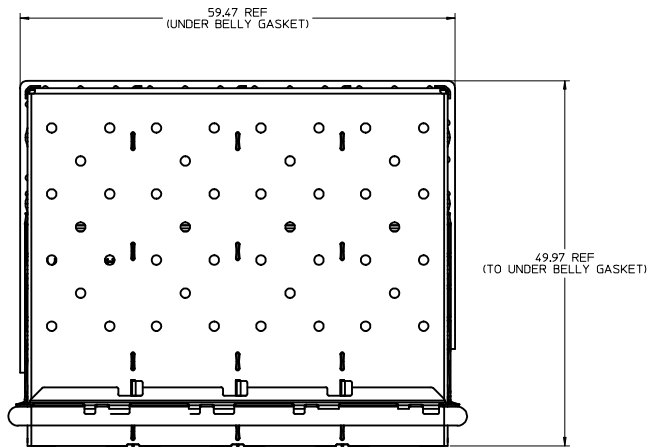

1. OPTIONAL UNDER BELLY GASKET ATTACHED TO BOTTOM OF CAGE (SEE P/N TABLES FOR AVAILABLE ASSEMBLIES)

<b>ENTER DESCRIPTION</b> IEC NO: CPG2016-2975 CHYD: DRWNA:CHENG03 APPR:RCHEN08 2016/02/04	QUALITY SYMBOLS	GENERAL TOLERANCES (UNLESS SPECIFIED)		DIMENSION STYLE	SCALE	DESIGN UNITS	THIRD ANGLE PROJECTION
	▽=0	4 PLACES	mm INCH	MM ONLY	3:1	METRIC	
	▽=0	3 PLACES					
	▽=0	2 PLACES					
		ANGULAR ± 1°					
		DRAFT WHERE APPLICABLE MUST REMAIN WITHIN DIMENSIONS					
				MATERIAL NO.	DOCUMENT NO.		SHEET NO.
				SEE TABLE	SD-111112-2410		3 OF 9
				THIS DRAWING CONTAINS INFORMATION THAT IS PROPRIETARY TO MOLEX INCORPORATED AND SHOULD NOT BE USED WITHOUT WRITTEN PERMISSION			

PART NUMBER SELECTION

1111120410  
SHOWN

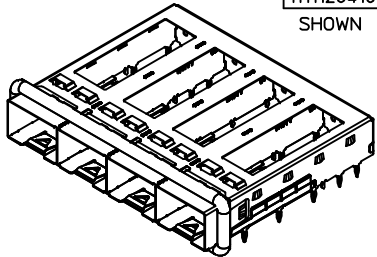

OPEN TOP BASE CAGE FOR HEATSINK		
PART NO.	POLYIMIDE INSULATOR	# OF REAR LEGS PER PORT
1111120410	---	1A, 1B
1111120450	YES	1A, 1B

1111122410  
SHOWN

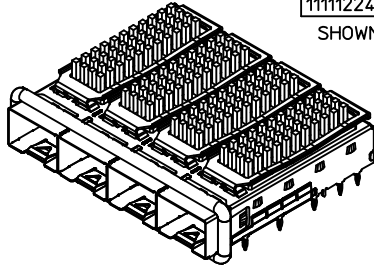

PIN FIELD HEATSINK OPTION			
PART NO.	POLYIMIDE INSULATOR	HEATSINK	# OF REAR LEGS PER PORT
1111121410	---	PCI	1A, 1B
1111121450	YES	PCI	1A, 1B
1111122410	---	SAN	1A, 1B
1111122450	YES	SAN	1A, 1B
1111123410	---	NET	1A, 1B
1111123450	YES	NET	1A, 1B

NOTE: PCI - 13 ROWS  
SAN - 11 ROWS  
NET - 10 ROWS

1111125410  
SHOWN

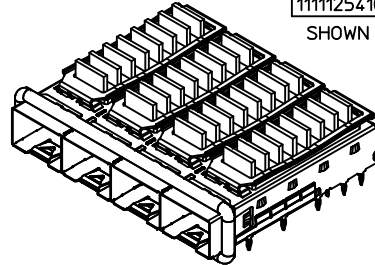

LATERAL FIN HEATSINK OPTION			
PART NO.	POLYIMIDE INSULATOR	HEATSINK	# OF REAR LEGS PER PORT
1111124410	---	PCI	1A, 1B
1111124450	YES	PCI	1A, 1B
1111125410	---	SAN	1A, 1B
1111125450	YES	SAN	1A, 1B
1111126410	---	NET	1A, 1B
1111126450	YES	NET	1A, 1B

1111128410  
SHOWN

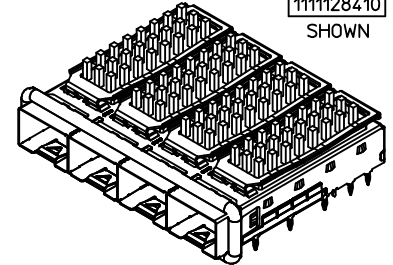

WIDE GAP PIN FIELD HEATSINK OPTION			
PART NO.	POLYIMIDE INSULATOR	HEATSINK	# OF REAR LEGS PER PORT
1111127410	---	PCI	1A, 1B
1111127450	YES	PCI	1A, 1B
1111128410	---	SAN	1A, 1B
1111128450	YES	SAN	1A, 1B
1111129410	---	NET	1A, 1B
1111129450	YES	NET	1A, 1B

747540410  
SHOWN

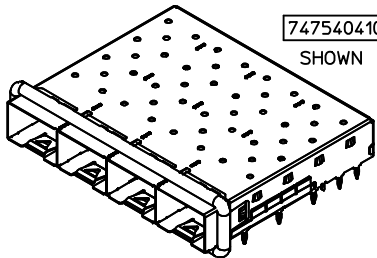

SFP+ CLOSED TOP BASE CAGE			
PART NO.	POLYIMIDE INSULATOR	# OF REAR LEGS PER PORT	ELASTOMERIC GASKET FLAMMABILITY RATING
747540410	---	1A, 1B	
747540411	---	3A	
747540415	---	1A, 1B	
747540419	---	1A, 1B	
747540470	---	1A, 1B	EQUATE TO UL94 V-0

1001140410  
SHOWN

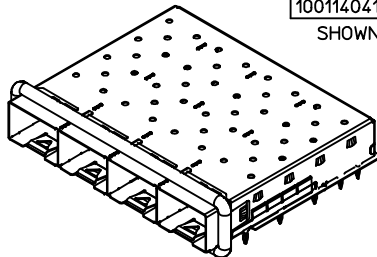

zSFP+ CLOSED TOP BASE CAGE W/ GEN 2 BELLY GASKET		
PART NO.	# OF REAR LEGS PER PORT	FLAMMABILITY RATING
1001140410	1A, 1B	N/A
1001144410	1A, 1B	UL94 V-0

<b>SEE REVISION TABLE</b> EC NO: CPG2016-2975 DRAWN: CHENG03 CHKD: APPR: CHEN08 2016/02/04	QUALITY SYMBOLS ▽=0 ▽=0 ▽=0	GENERAL TOLERANCES (UNLESS SPECIFIED)		DIMENSION STYLE <b>MM ONLY</b>	SCALE <b>2:1</b>	DESIGN UNITS <b>METRIC</b>	THIRD ANGLE PROJECTION	
		4 PLACES ± mm INCH 3 PLACES ± --- ± --- 2 PLACES ± 0.13 ± --- 1 PLACE ± 0.25 ± --- 0 PLACE ± --- ± ---		DRAWN BY JHATTON		DATE 2012/12/03		TITLE <b>SFP+ 1X4 CAGE, 3.05MM PRESS FIT, HEAT SINK, ELASTOMERIC GASKET</b>  <b>molex</b>
		ANGULAR ± 1 ° DRAFT WHERE APPLICABLE MUST REMAIN WITHIN DIMENSIONS		CHECKED BY MMCKERVEY		DATE 2012/12/07		
				APPROVED BY K LLOYD		DATE 2012/12/20		
		MATERIAL NO. <b>SEE TABLE</b>		DOCUMENT NO. <b>SD-11112-2410</b>		SHEET NO. 4 OF 9		

THIS DRAWING CONTAINS INFORMATION THAT IS PROPRIETARY TO MOLEX INCORPORATED AND SHOULD NOT BE USED WITHOUT WRITTEN PERMISSION

# PCB LAYOUT FOR SINGLE SIDE MOUNT

HATCHED AREA DENOTES COMPONENTS AND TRACE KEEP-OUT (EXCEPT CHASSIS GROUND)

CROSS HATCHED AREA GOES TO CHASSIS GROUND (NO OSP) 4 PLCS

14X  $\phi 1.05 \pm 0.05$  (SHOWN AS  $\oplus$ )  
 $\oplus 0.05 \text{ AB}$

THIS AREA DENOTES COMPONENT KEEP-OUT (TRACES ALLOWED)

20X  $\phi 0.95 \pm 0.05$  (SHOWN AS  $\bullet$ )  
 $\bullet 0.05 \text{ AB}$

4X  $\phi 0.95 \pm 0.05$  (SHOWN AS  $\oplus$ )  
 $\oplus 0.05 \text{ AB}$   
 OPTIONAL HOLES FOR CAGES WITH 3 REAR LEGS PER PORT

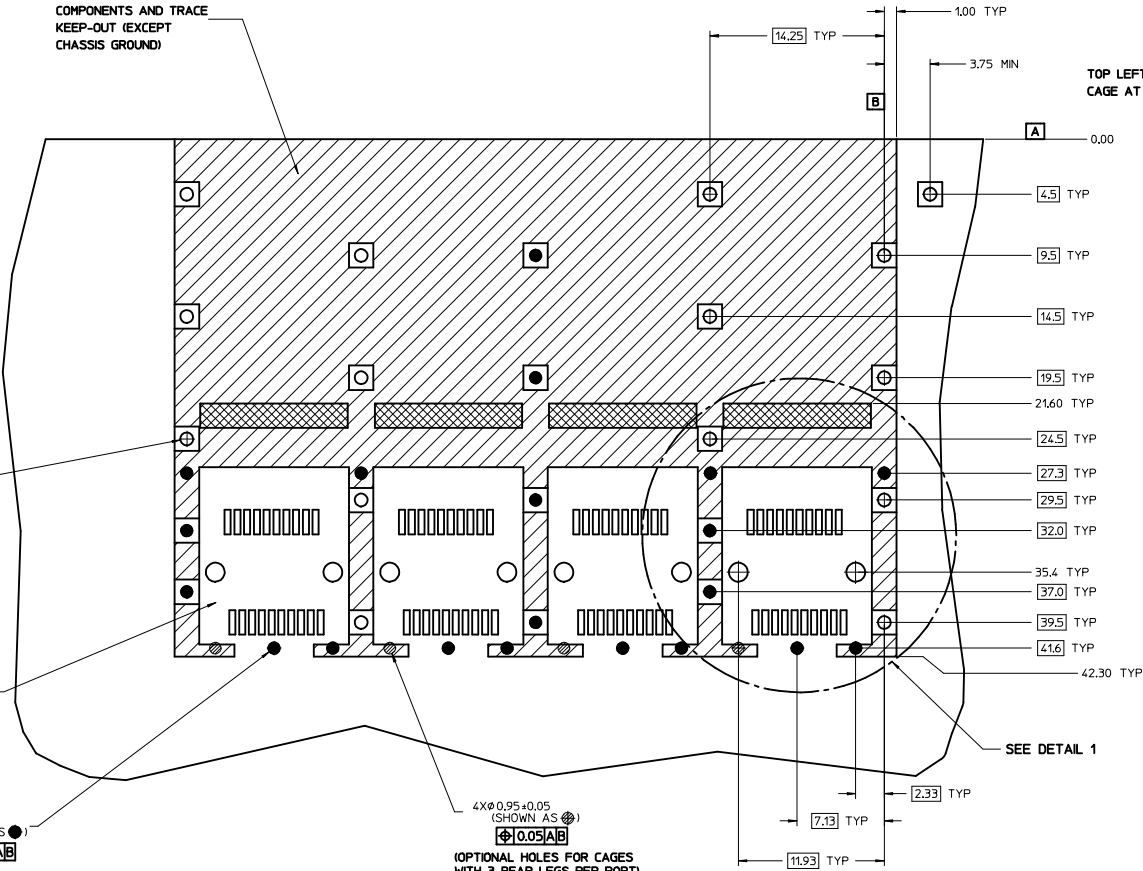

## HOST CONNECTOR DETAIL

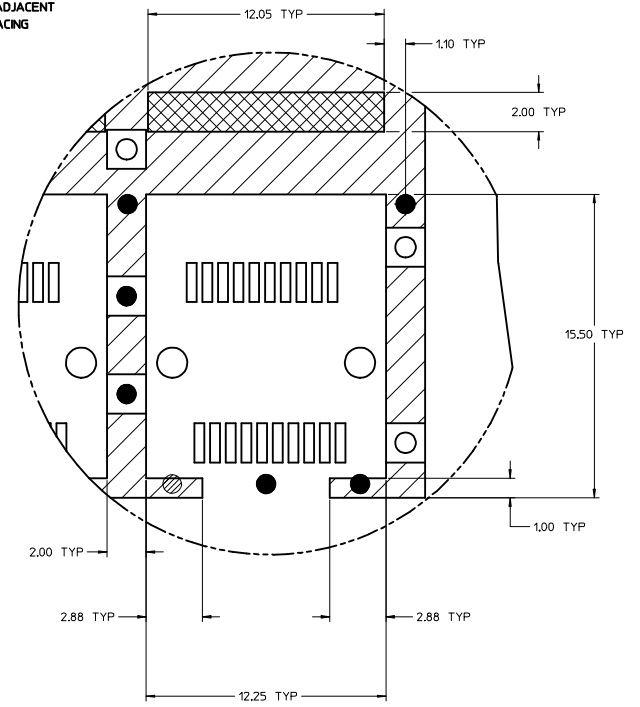

DETAIL 1  
SCALE 8:1

**NOTES:**

1. PADS AND VIAS CONNECT TO CHASSIS GROUND (RECOMMENDED PADS TO BE 2.00mm SQUARE)
2. RECOMMENDED THRU HOLE PLATING INCLUDES HASL, OSP, OR IMMERSION (GOLD, SILVER, OR TIN)
3. CONNECTOR PAD LAYOUT PER SFP+ MSA WILL ACCOMMODATE MOLEX CONNECTOR SERIES 74441 OR EQUIVALENT
4. HOLE PATTERN REPEATS FOR EACH PORT, SPACING BETWEEN PORTS IS 14.25mm
5. MINIMUM PCB THICKNESS FOR SINGLE SIDED USE 157mm [0.062"].

<b>SEE REVISION TABLE</b> EC NO: CPG2016-2975 DRAWN BY: JHATTON CHYD: MCKRVEY APPR: KLOYD DATE: 2016/02/03 DATE: 2012/12/07 DATE: 2012/12/20	QUALITY SYMBOLS	GENERAL TOLERANCES (UNLESS SPECIFIED)	DIMENSION STYLE	SCALE	DESIGN UNITS	THIRD ANGLE PROJECTION
	$\nabla=0$ $\nabla=0$ $\nabla=0$	mm INCH 4 PLACES ± --- ± --- 3 PLACES ± --- ± --- 2 PLACES ± 0.13 ± --- 1 PLACE ± 0.25 ± --- 0 PLACE ± --- ± ---	MM ONLY	5:1	METRIC	
	DRAWN BY: JHATTON CHECKED BY: MCKRVEY APPROVED BY: KLOYD DATE: 2012/12/03 DATE: 2012/12/07 DATE: 2012/12/20	ANGULAR ± 1 ° DRAFT WHERE APPLICABLE MUST REMAIN WITHIN DIMENSIONS	MATERIAL NO: <b>SEE SHEET 3</b>	TITLE: SFP+ 1X4 CAGE, 3.05MM PRESS FIT, HEAT SINK, ELASTOMERIC GASKET	DOCUMENT NO: SD-111112-2410	SHEET NO: 5 OF 9
	THIS DRAWING CONTAINS INFORMATION THAT IS PROPRIETARY TO MOLEX INCORPORATED AND SHOULD NOT BE USED WITHOUT WRITTEN PERMISSION					

# PCB LAYOUT FOR BELLY TO BELLY MOUNTING

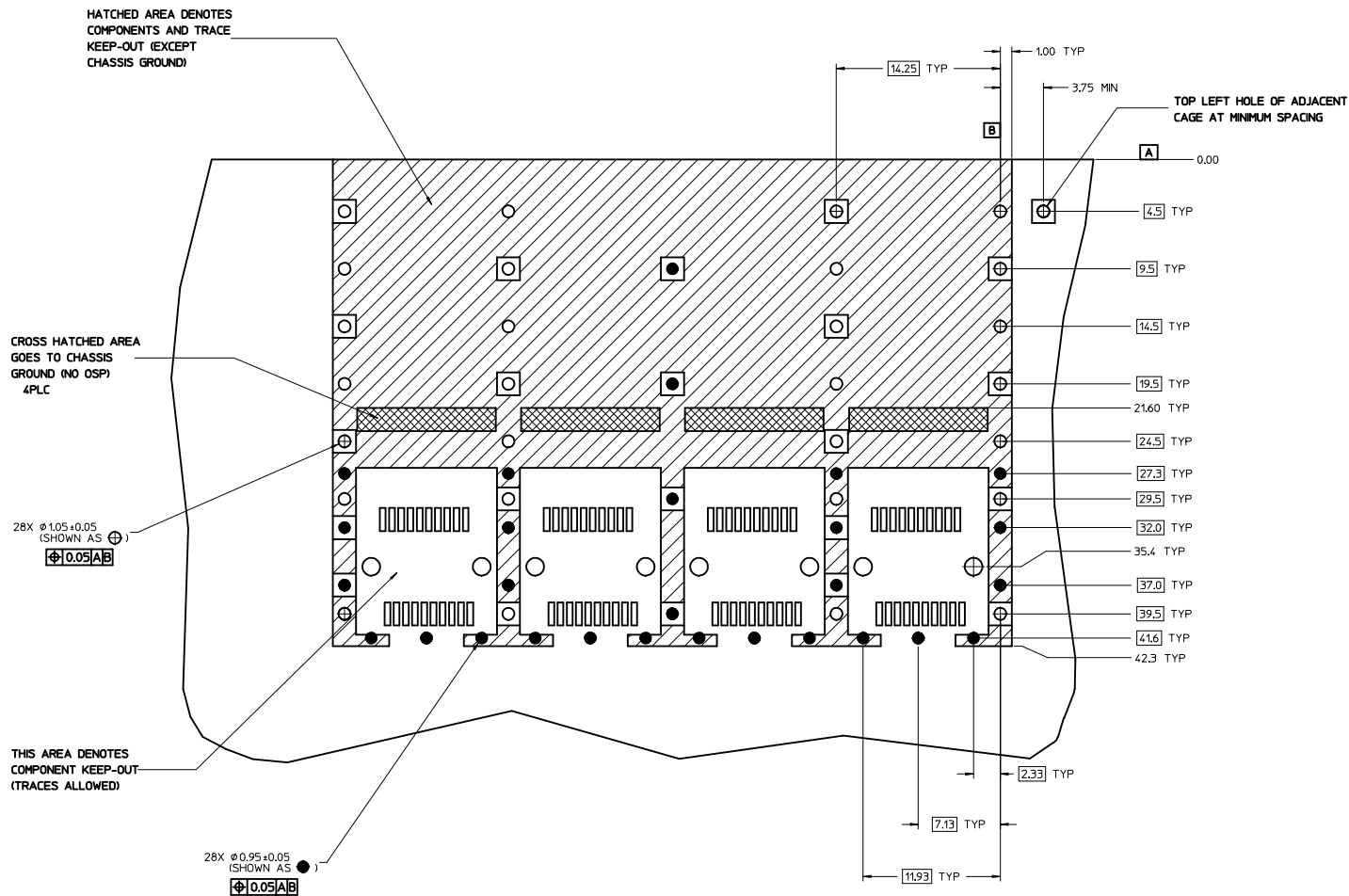

NOTE:  
SEE SHEET 5 FOR HOST  
CONNECTOR DETAIL

**NOTES:**

1. PADS AND VIAS CONNECT TO CHASSIS GROUND (RECOMMENDED PADS TO BE 2.00mm SQUARE)
2. RECOMMENDED THRU HOLE PLATING INCLUDES HASL, OSP, OR IMMERSION (GOLD, SILVER, OR TIN)
3. CONNECTOR PAD LAYOUT PER SFP+ MSA WILL ACCOMMODATE MOLEX CONNECTOR SERIES 74441 OR EQUIVALENT
4. HOLE PATTERN REPEATS FOR EACH PORT, SPACING BETWEEN PORTS IS 14.25mm
5. MINIMUM PCB THICKNESS FOR BELLY TO BELLY USE 3.00mm [0.118"].

<b>SEE REVISION TABLE</b> IEC NO: CPG2016-2975 DRAWN: ACHENG03 CHKD: APPR: RCHENG08 2016/02/04	QUALITY SYMBOLS	GENERAL TOLERANCES (UNLESS SPECIFIED)	DIMENSION STYLE	SCALE	DESIGN UNITS	THIRD ANGLE PROJECTION
	▽=0	mm INCH	MM ONLY	5:1	METRIC	
	▽=0	4 PLACES ± --- ± ---	DRAWN BY	DATE	TITLE	
	▽=0	3 PLACES ± --- ± ---	JHATTON	2012/12/03	SFP+ 1X4 CAGE, 3.05MM PRESS FIT, HEAT SINK, ELASTOMERIC GASKET	
		2 PLACES ± 0.13 ± ---	CHECKED BY	DATE		
		1 PLACE ± 0.25 ± ---	MMCKERVEY	2012/12/07		
		0 PLACE ± --- ± ---	APPROVED BY	DATE		
		ANGULAR ± 1 °	KLLOYD	2012/12/20		
		DRAFT WHERE APPLICABLE MUST REMAIN WITHIN DIMENSIONS	MATERIAL NO.	DOCUMENT NO.	SHEET NO.	
			SEE SHEET 3	SD-111112-2410	6 OF 9	
			THIS DRAWING CONTAINS INFORMATION THAT IS PROPRIETARY TO MOLEX INCORPORATED AND SHOULD NOT BE USED WITHOUT WRITTEN PERMISSION			

POLYIMIDE INSULATOR COVERAGE AREA  
(APPLIES TO SINGLE SIDED AND BELLY TO BELLY)

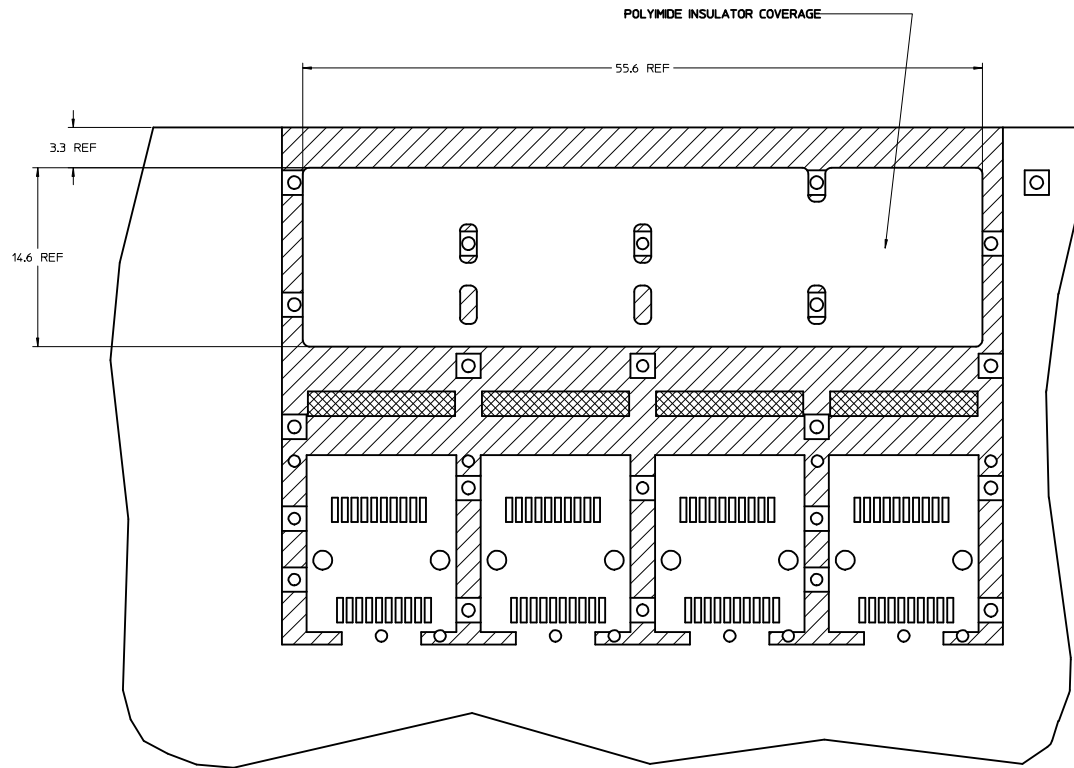

<b>SEE REVISION TABLE</b> EC NO: CPG2016-2975 CHYD: DRWNA/CHENG03 APPROV: CHEN08 2016/02/04	QUALITY SYMBOLS	GENERAL TOLERANCES (UNLESS SPECIFIED)	DIMENSION STYLE	SCALE	DESIGN UNITS	THIRD ANGLE PROJECTION
	▽=0	mm INCH	MM ONLY	5:1	METRIC	
	▽=0	4 PLACES ± --- ± ---	DRAWN BY	DATE	TITLE	
	▽=0	3 PLACES ± --- ± ---	JHATTON	2012/12/03	SFP+ 1X4 CAGE, 3.05MM PRESS FIT, HEAT SINK, ELASTOMERIC GASKET	
		2 PLACES ± 0.13 ± ---	CHECKED BY	DATE		
		1 PLACE ± 0.25 ± ---	MMCKERVEY	2012/12/07		
		0 PLACE ± --- ± ---	APPROVED BY	DATE		
		ANGULAR ± 1 °	KLLOYD	2012/12/20		
		DRAFT WHERE APPLICABLE MUST REMAIN WITHIN DIMENSIONS	MATERIAL NO.	DOCUMENT NO.		
			SEE SHEET 3	SD-11112-2410		
			THIS DRAWING CONTAINS INFORMATION THAT IS PROPRIETARY TO MOLEX INCORPORATED AND SHOULD NOT BE USED WITHOUT WRITTEN PERMISSION			
					SHEET NO.	
					7 OF 9	

BEZEL AND BOARD POSITION DIMENSIONS FOR SINGLE SIDE MOUNTING  
(ELASTOMERIC GASKET)

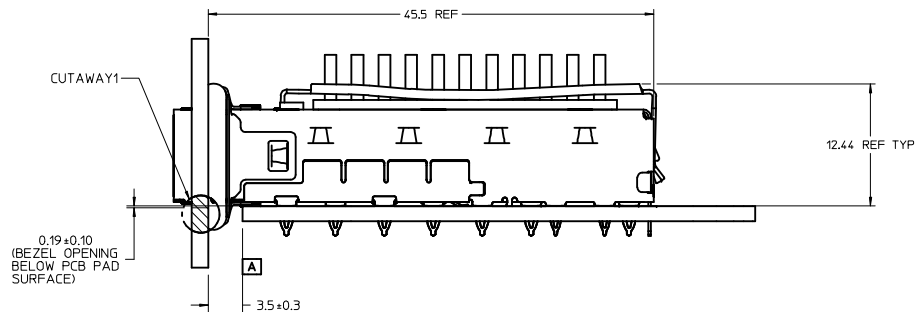
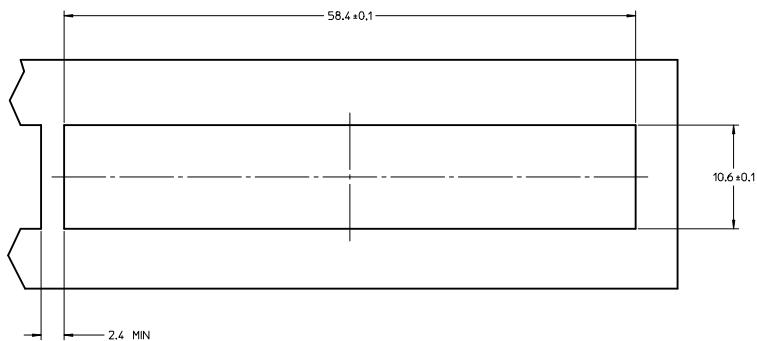

BEZEL AND BOARD POSITION DIMENSIONS FOR BELLY TO BELLY MOUNTING  
(ELASTOMERIC GASKET)

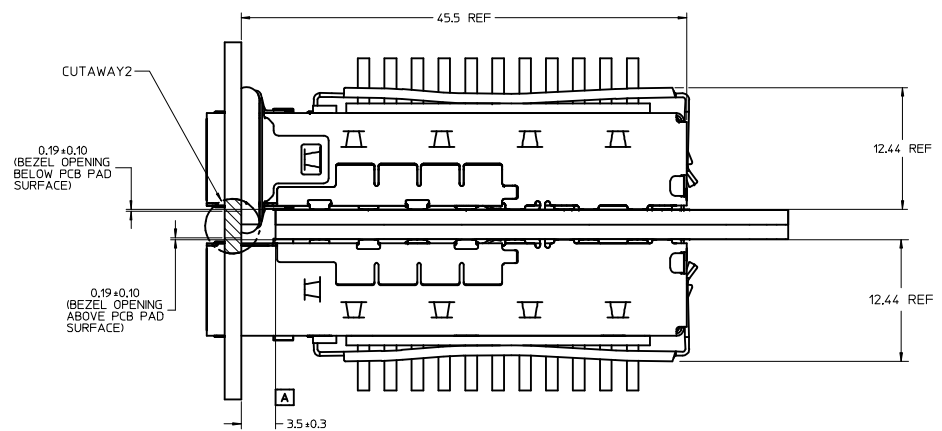
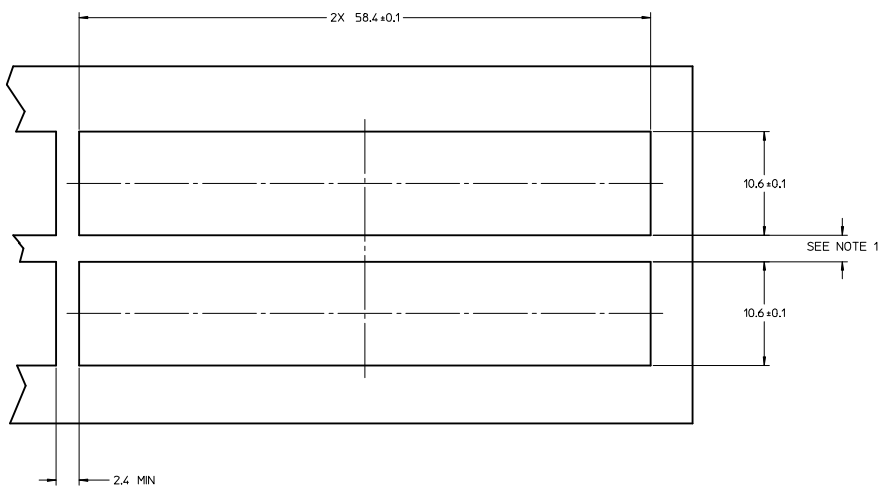

- NOTE:
- PCB THICKNESS VARIATION MUST BE CONSIDERED WHEN DETERMINING BEZEL OPENING LOCATION.
  - CAGE LEG STANDOFF WILL PIERCE BELLY GASKET WHEN PROPERLY PRESSED INTO PCB.

<b>SEE REVISION TABLE</b> EEC NO: CPG2016-2975 CHYD: DRWNA/CHENG03 APPROV: CHEN08 DATE: 2016/02/04	QUALITY SYMBOLS	GENERAL TOLERANCES (UNLESS SPECIFIED)	DIMENSION STYLE	SCALE	DESIGN UNITS	THIRD ANGLE PROJECTION
	▽=0	mm INCH	MM ONLY	4:1	METRIC	
	▽=0	4 PLACES ± --- ± ---	DRAWN BY	TITLE		
	▽=0	3 PLACES ± --- ± ---	JHATTON	SFP+ 1X4 CAGE, 3.05MM PRESS FIT, HEAT SINK, ELASTOMERIC GASKET		
	2 PLACES ± 0.13 ± ---	2 PLACES ± 0.25 ± ---	DATE	MATERIAL NO.		
	1 PLACE ± --- ± ---	0 PLACE ± --- ± ---	DATE	DOCUMENT NO.		
	ANGULAR ± 1 °	DRAFT WHERE APPLICABLE MUST REMAIN WITHIN DIMENSIONS	DATE	SHEET NO.		
			2012/12/03	SEE SHEET 3		
			2012/12/07	SD-111112-2410		
			2012/12/20	8 OF 9		
				THIS DRAWING CONTAINS INFORMATION THAT IS PROPRIETARY TO MOLEX INCORPORATED AND SHOULD NOT BE USED WITHOUT WRITTEN PERMISSION		



DATE	REV	DESCRIPTION
2012/12/03	A	1. INITIAL RELEASE
2013/01/23	B	1. REMOVED EMI GASKET FROM TOP, @I16, AND RIGHT SIDE, @E12, VIEWS FOR CLARITY. ADDED EMI GASKET UNCOMPRESSED OVERALL DIMENSIONS TO FRONT VIEW, @E16. ADDED 9.98 REF DIM. TO SIDE VIEW. ADDED BACK VIEW W/INNER WALL WELD NOTE, @E3. REMOVED BELLY ISO VIEW CHANGED ALL VIEWS ON SHEET 1 TO 747540410 CLOSED TOP BASE CAGE. MOVED MIN PCB THICKNESS NOTE TO RESPECTIVE PCB LAYOUT SHEETS. REMOVED INSERTION FORCE FROM NOTE 2. UPDATED PN/DATE CODE PRINTING CALLOUT ON SIDE VIEW. ADDED FIX TEXT OVERALL LENGTH TO DIM. 49.0 REF @J14. ADDED APPLICATION NOTE @M10. ADDED TYP TO DIMENSION 3.05 REF ON SIDE VIEW @E8 (SHEET 1). 2. ADDED 'REAR LEG OPTIONS' SECTION, @B16. REMOVED CAGES FROM HEATSINK OPTIONS VIEWS & UPDATED TABLES, @J2, J6 & J11. MOVED BELLY VIEW TO, D9. ADDED BELLY VIEW @D3. ADDED OPEN TOP VIEW @17. ADDED OVERALL HEATSINK NOTE TO TABLES @12, 16, & 111. ADDED ▽ & ▽ TO ISO BELLY VIEW @D3. (SHEET 2). 3. ADDED PN'S 747540410, 747540411, 747540415, 747540419 & 1111110410 ADDING VIEWS AND PN TABLES. ADDED # OF REAR LEGS PER PORT COLUMN TO TABLES. (SHEET 3) 4. REMOVED BASIC TOLERANCE FROM DIMENSION 35.4 TYP, @F8. ADDED MIN PCB THICKNESS NOTE. ADDED DIAMETER DIMENSION Ø0.95 ± 0.05 X4 @D15. MOVED TYP FROM DIMENSION BOXES. ADDED DATUM A & DATUM B. ADDED NOTES 1 THRU 4. (SHEET 4) 5. REMOVED BASIC TOLERANCE FROM DIMENSION 35.4 TYP, @F5. ADDED MIN PCB THICKNESS NOTE. REMOVED PAD @F14. ADDED NOTES 1 THRU 4. (SHEET 5). 6. REMOVED BELLY TO BELLY PCB VIEW, CENTERED SINGLE SIDED VIEW AND ADDED APPLICATION NOTE TO SHEET TITLE. REMOVED DIMENSION 1.7 REF (SHEET 6) 7. CHANGED TOLERANCE ON DIMENSIONS 0.19 TO 0.19 ±0.10, @D9 & F9. ADDED CENTER LINES TO BEZELS. REMOVED 'CUTAWAY'S FROM SIDE VIEWS. REMOVED 'SEE NOTE 1' FROM 10.6 ±0.1 BEZEL OPENING SIZE DIMENSIONS @D10 & E10. REMOVED 'SIZE, AND' FROM NOTE 1. ADDED 'SEE NOTE 1' TO BELLY TO BELLY BEZEL OPENING PITCH. (SHEET 7) 8. MOVED NOTES TO BOTTOM LEFT CORNER AND INCREASED TEXT HEIGHT, (SHEETS 1, 4, 5 & 7). CHANGED DRAWING DIMENSION STYLE TO MM ONLY. CHANGED THE GENERAL ANGLE TOLERANCE TO 1° FOR ALL SHEETS.
2014/02/05	C	1. MOVED DATE CODE FROM VIEW @E9 TO VIEW @E5. REVISED NOTE 4 'WAS' WELD SPOT WILL SHOW SLIGHT MATERIAL DISCOLORATION. 'NOW READS' WELD SPOT MAY SHOW SLIGHT MATERIAL DISCOLORATION SHEET 1. 2. MOVED VIEW @E4 SHEET 2 TO THE REVISED SHEET 3 @K4. ADDED VIEW AND DATE CODE @E5. 3. ADDED NEW SHEET 3: PREVIOUS SHEET 3-8 INCREASED BY ONE NUMBER. ADDED NOTE 1 @A20. REMOVED NOTE FROM ISO VIEW @16. 4. ADDED VIEW @F8 AND REVISED PART NUMBER 'WAS' 747540410. 'NOW READS' 1111110410 @G12 SHEET 4.
2014/05/12	D	1. ADDED P/N 74754-0470 [SHEET 4]
2014/09/09	E	1. ADDED P/N 100114-4410. [SHEET 4]
2015/07/16	F	1. REVISED COLUMN LABEL UL RATING TO FLAMMABILTY RATING IN TABLE @D7. 2. REVISED PART NO. 100114-4410 NOTES @D7 'WAS' UL TESTING PENDING. 'NOW' UL94 V-0. SHEET 4 3. ADDED NOTE 2 @A20. SHEET 8
2015/10/26	G	SHEET 1: A19: ADDED NOTE *7. MOST OF P/N ARE WITH 14.05 REF EXCEPT 747540415 & 747540419 ARE 12.55 REF*. E12: CHANGED '14.05 REF (ACROSS FRAME)' TO 'SEE NOTE 7. (ACROSS FRAME)'.
2016/02/03	H	1. SHEET 3 & 4: REMOVE 1111110410.

SEE REVISION TABLE EEC NO: CPG2016-2975 DRAWN BY: DRWACHENG03 CHKD: CHYK APPROVED BY: APPRACHENG08 DATE: 2016/02/04	QUALITY SYMBOLS	GENERAL TOLERANCES (UNLESS SPECIFIED)	DIMENSION STYLE	SCALE	DESIGN UNITS	THIRD ANGLE PROJECTION
	▽=0	4 PLACES ±--- ±---	MM ONLY	1:1	METRIC	DRAWN BY: JHATTON DATE: 2012/12/03 CHECKED BY: DATE: MMCKERVEY DATE: 2012/12/07 APPROVED BY: DATE: K LLOYD DATE: 2012/12/20 MATERIAL NO. _____ DOCUMENT NO. SD-111112-2410 SHEET NO. 9 OF 9
	▽=0	3 PLACES ±--- ±---				
	▽=0	2 PLACES ±0.13 ±---				
▽=0	1 PLACE ±0.25 ±---					
		0 PLACE ±--- ±---				
		ANGULAR ± 1 °				
		DRAFT WHERE APPLICABLE MUST REMAIN WITHIN DIMENSIONS	SEE SHEET 3			
			THIS DRAWING CONTAINS INFORMATION THAT IS PROPRIETARY TO MOLEX INCORPORATED AND SHOULD NOT BE USED WITHOUT WRITTEN PERMISSION			