

MASSE OHNE TOLERANZ SIND KEINE PRUEFMASSE
 DIMS. WITHOUT TOLERANCE ARE NOT CONTROL DIMS.

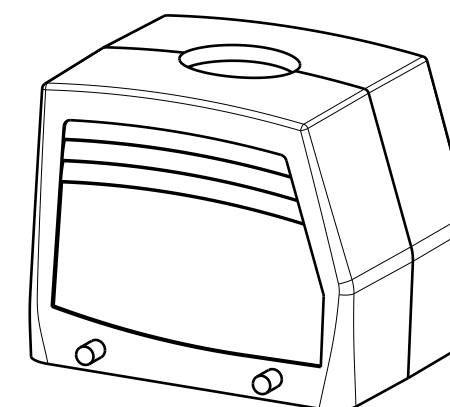
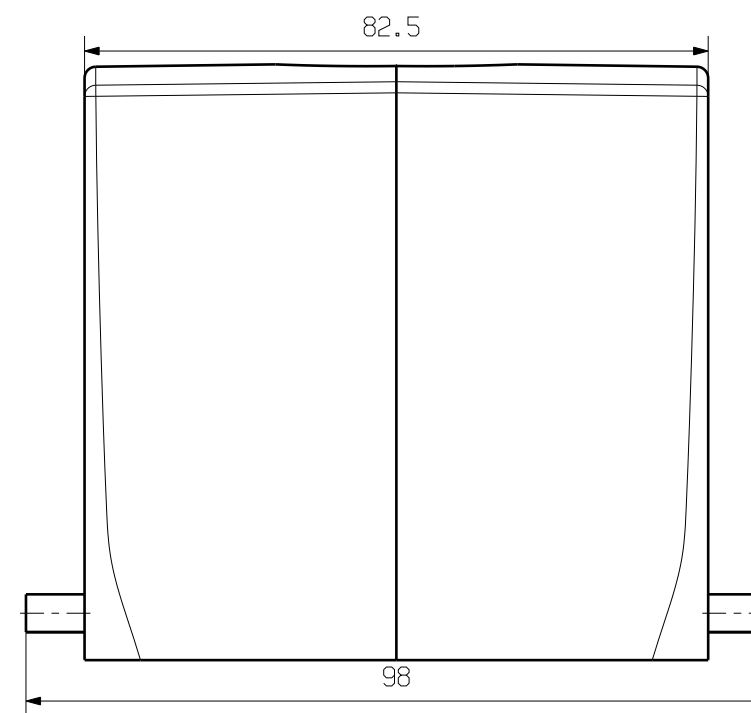
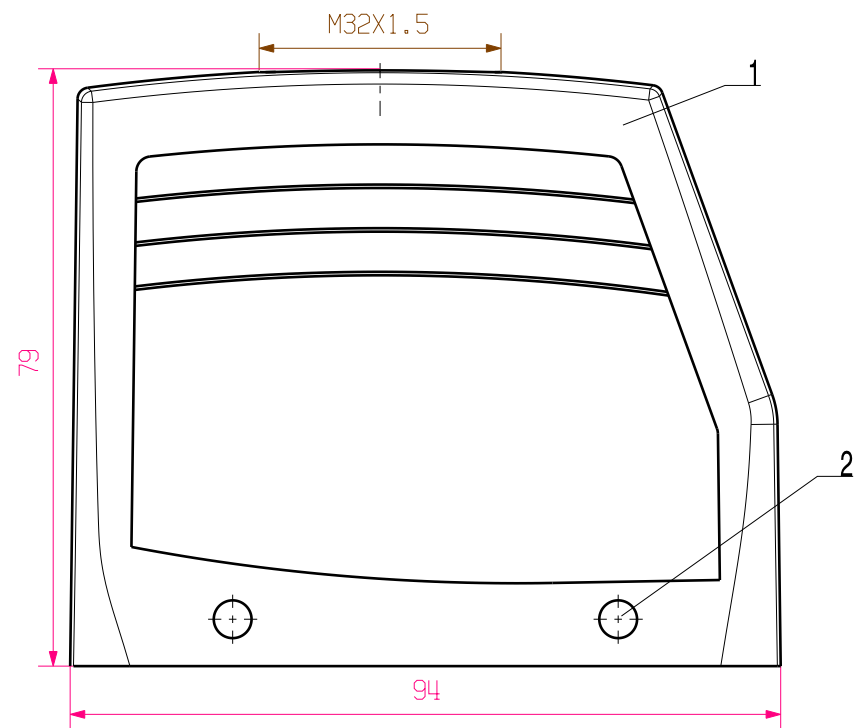

2	LOCKING BOLTS	STAINLESS STEEL
1	PLUG HOOD HOUSING	ALUMINIUM WITH POWDER COATING
ROHSTOFF-NR. R.PART NO.	TYP PART NAME	WERKSTOFF MATERIAL

CAT.NO.: 1788430000

MAX. NRN./NOS. ? 		Weidmüller		DRAWING NO.	ISSUE NO.
MODIFICATION		DATE	NAME	HDC 32B TOBU 1M32G STECKERGEHAEUSE PLUG HOOD HOUSING	
SCALE: 1/1	DRAWN	17.11.2005	LIU_F		
SUPERSEDES:	CHECKED	30.11.2005	ZHANG_T		
SUPERSEDED BY:	APPROVED				
PRODUCT FILE:					

WEITERGABE SOWIE VERVIELFÄLTIGUNG DIESES DOKUMENTS, VERWERTUNG UND MITTEILUNG SEINES INHALTS SIND VERBOTEN, SOWEIT NICHT AUSDRUECKLICH GESTATET.
 ZUWIDERHANDLUNGEN VERPFLICHTEN ZU SCHADENERSATZ. ALLE RECHTE FUER DEN FALL DER PATENT-, GEBRAUCHSMUSTER- ODER GESCHMACKSMUSTEREINTRAGUNG VORBEHALTEN.
 THE REPRODUCTION, DISTRIBUTION AND UTILIZATION OF THIS DOCUMENT AS WELL AS THE COMMUNICATION OF ITS CONTENTS TO OTHERS WITHOUT EXPLICIT AUTHORIZATION IS PROHIBITED.
 OFFENDERS WILL BE HELD LIABLE FOR THE PAYMENT OF DAMAGES. ALL RIGHTS RESERVED IN THE EVENT OF THE GRANT OF A PATENT, UTILITY MODEL OR DESIGN.