

90089-AS

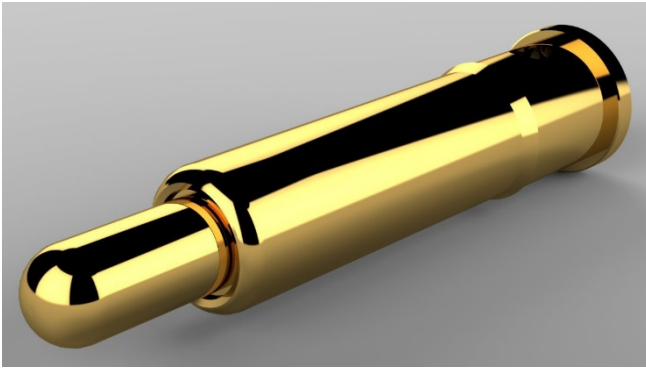

SMT SPRING LOADED CONTACT

Engineered for Success

Assembly: SMT
Height: 8.2mm (.323")
Stroke: 2.2mm (.087")

**ORDER AS:
90089-AS**

APPLICATION NOTES:

PRODUCT DESCRIPTION:

Preci-Dip Spring Loaded contact SMT termination for reflow soldering. Every Preci-Dip spring contact is Swiss precision machined and assembled for highest quality, performance and long product life.

PRODUCT PACKAGING:

This product is sold in bulk or on tape and reel. It can be supplied assembled in an insulator. Let us help you with your custom packaging request.

HOW TO USE THIS PRODUCT:

This product is ideal for PCB surface mount applications on .100" grid. With solid one-piece body construction, These spring loaded contacts are typically used in docking stations, recharging stations, module stacking and pluggable SLC requirements.

CAN I CUSTOMIZE THIS PRODUCT?

Preci-Dip welcomes custom design requests. Please provide us your spring force and packaging requirements. Call today to discuss your application.

Visit us at WWW.PRECI-DIP.COM

Temperature rise [°C]

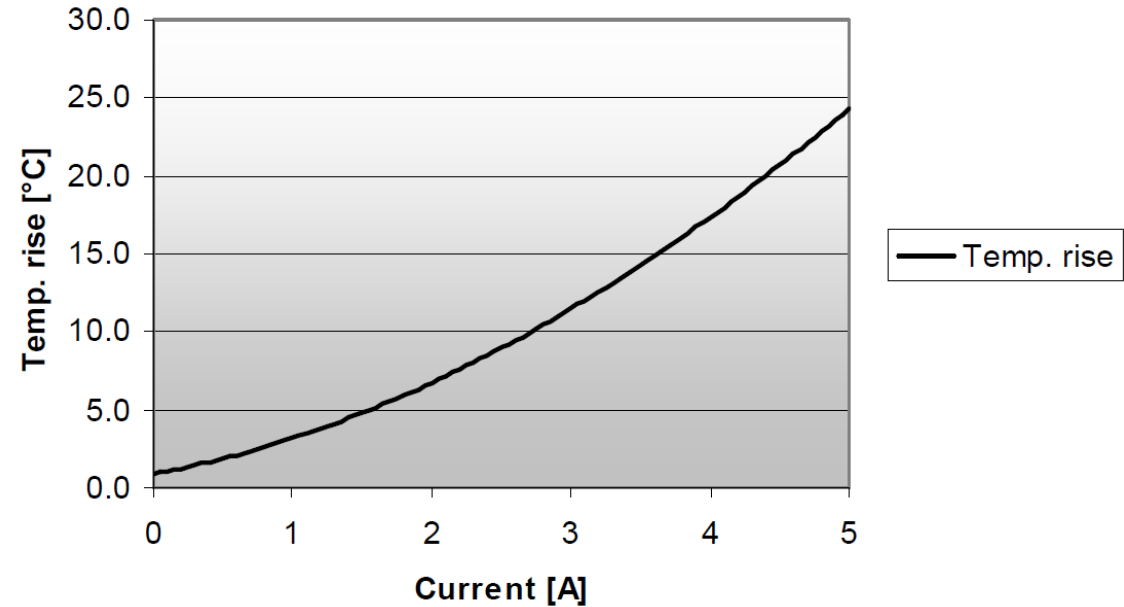

Current: 3A continuous @ 10 ° C rise

Surface Mount
Base

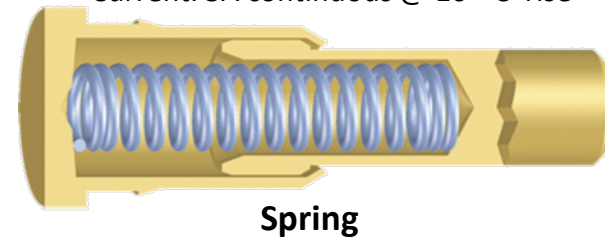

Piston

Spring

HOW IT WORKS:

Strong, secure and featuring one piece solid body construction, there are no capped components at the bottom of this spring contact. No seams for solder to wick inside the shell.



preci-dip



90089-AS

SMT SPRING LOADED CONTACT

Visit us at WWW.PRECI-DIP.COM



preci-dip

SPECIFICATIONS:

MATERIAL:

Piston: Brass Alloy, plated 0.5um (20μ") Gold
Barrel: Brass Alloy, plated 0.5um (20μ") Gold
Spring: Stainless Steel

ELECTRICAL:

Current: 3A continuous @ @ 10 ° C rise. 5A Peak.
Rated Voltage: 100Vrms 150Vdc
Contact Resistance: 20mΩ max..

ENVIRONMENTAL

Operating Temperature: -55 to 125° C
Passed Vibration Test Sinusoidal per IEC 512.6d / IEC 68-2-6
Passed Shock Test per IEC 512.6d / IEC 68-2-27
No electrical discontinuity greater than 1μs.

SPRING CONTACT FEATURES:

- * Swiss Experience
- * Swiss Quality
- * Swiss precision machined components
- * Seamless shell construction
- * Press-fit barb on barrel for packaging
- * Gold plating for corrosion resistance.
- * Smooth piston travel
- * High quality, smooth surface finish on tip of piston.
- * Strong and durable construction
- * RoHs

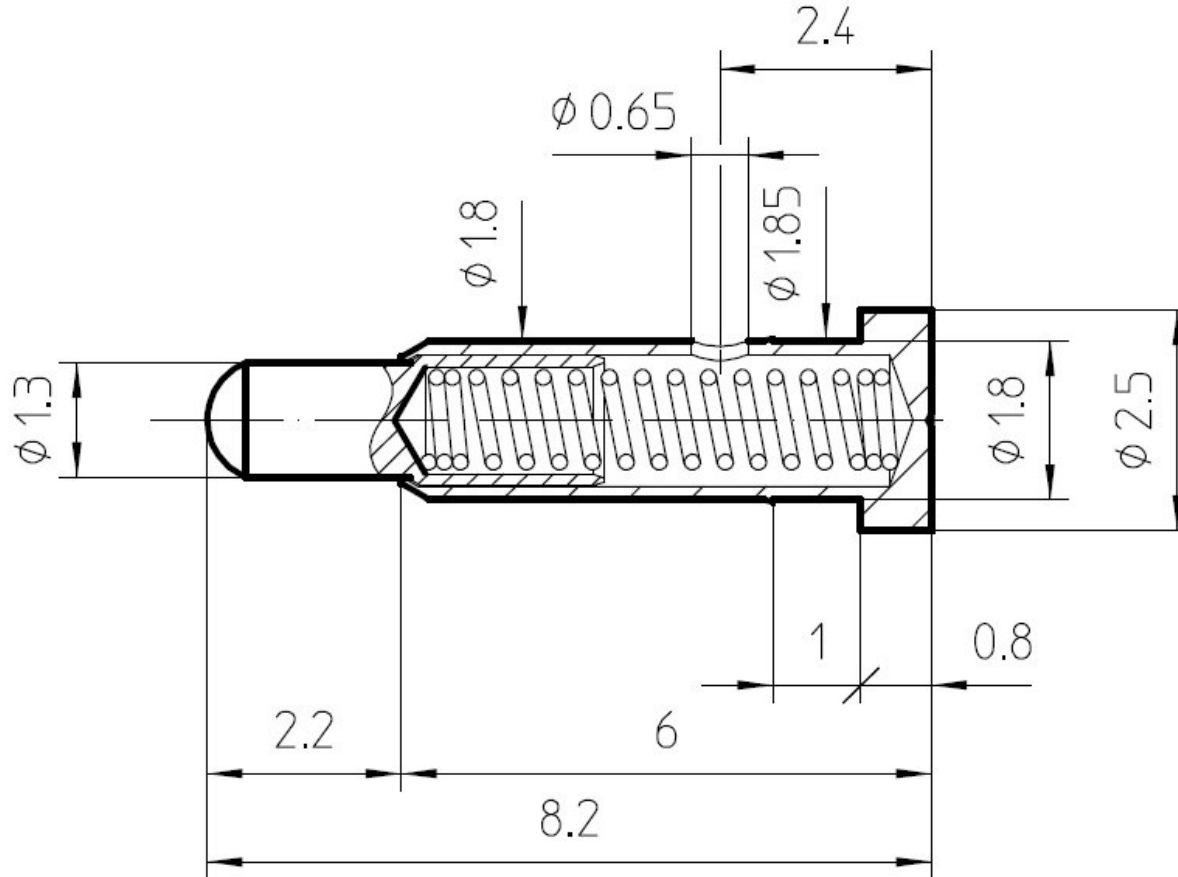

MECHANICAL

Durability: Minimum 40,000 cycles.
Stroke: 1.35mm (.053")
Working Travel: 8.2-6.05mm (.323-.238")
Force: Initial .4N
Half-Stroke 1.3N

HOW TO CUSTOMIZE A SPRING CONTACT

Specify:

1. Stacking distance between boards
2. Desired piston stroke
3. Desired spring force
4. Desired current rating.
5. Termination style SMT, Solder tail, Wire
6. Desired Cycle life

This product can be assembled in SIP or STRIP, and provided on Tape and Reel. Please inquire if interested.

