

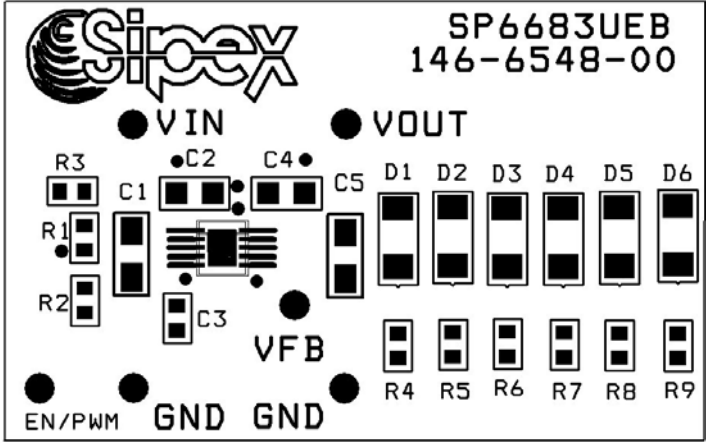

SP6683EB Evaluation Board Manual

- Low-profile, inductor-less White LED Driver, drives up to 8 WLEDs
- Automatic Transition from X1 to X1.5 mode for highest efficiency
- Build in 1.2 MHz oscillator enables using 1uF ceramic caps at 200mA output.
- PWM dimming control
- 1uA shutdown current
- Space Saving 10-pin DFN Package



SP6683 Evaluation Board Schematics

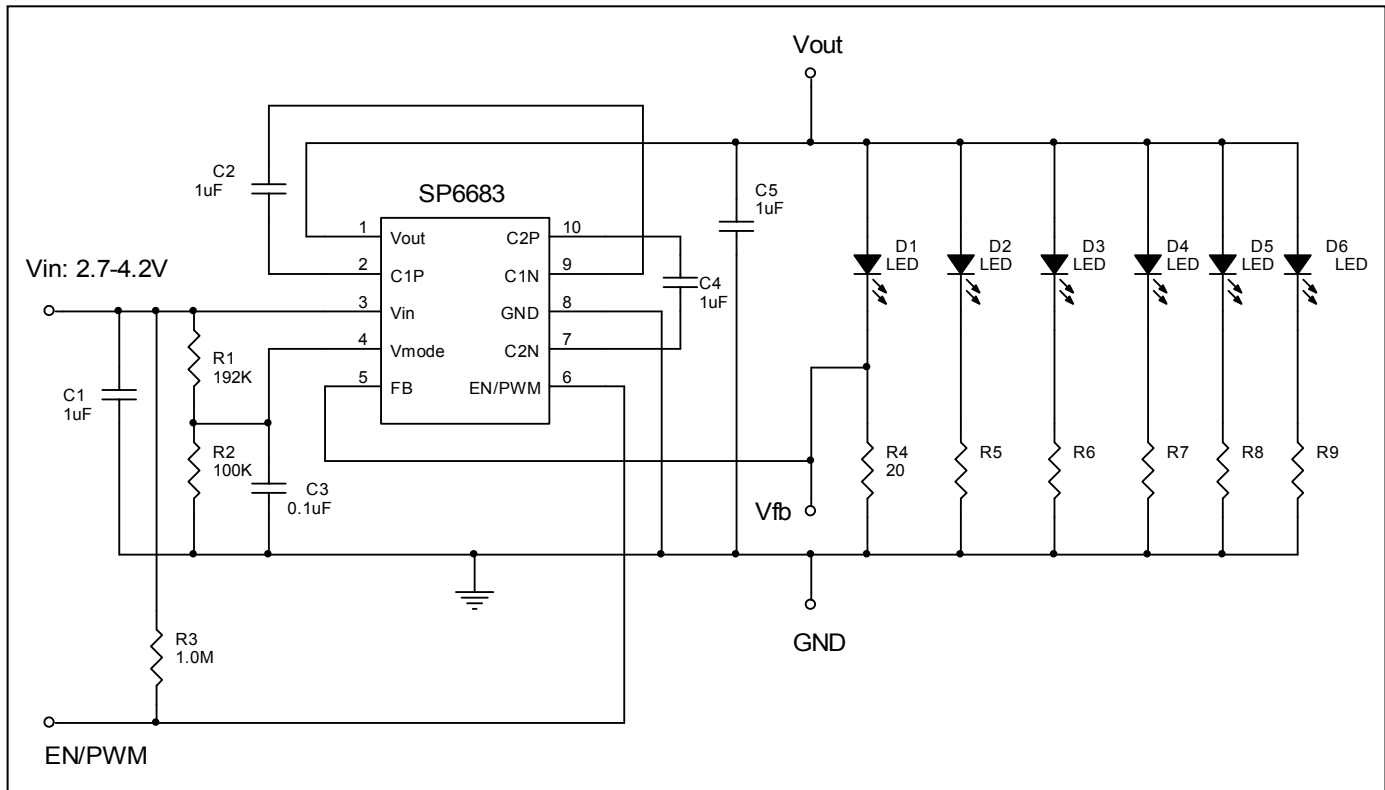

USING THE EVALUATION BOARD

1) Powering Up the SP6683 Circuit

The SP6683 Evaluation Board can be powered from inputs from a +2.7V to +5.5V battery or a power supply. Connect with short leads directly to the “VIN” and “GND” posts.

2) Using the evaluation board

The Evaluation Board was set up for a 4 15mA LED application even though there are 6 LED spots on the board. The output of SP6683 was open as default. If the customer has discrete white LEDs, then the discrete white LEDs should be soldered to the D1-D6 positions and bias resistors should be soldered to the R4-R9 positions. Selection of the bias resistors please refers to 3). If the customer has white LED module, they can plug the two terminals of the module to the “VOOUT” and “Vfb” posts, and use R4 as the bias current to regulate the total current. The value of the bias resistor could be calculated by equation (1).

3) Selecting the Bias Resistor

The bias resistor could be estimated by (1)

$$R_{Total} = V_{FB} / I_{LED_Total} = 0.3V / 60mA = 5\Omega \quad (1)$$

Where I_{LED_Total} is the total output current.

$$R_{4-9} = V_{FB} / I_{LED_D1-6} = 0.3V / 15mA = 20\Omega \quad (2)$$

Where I_{LED_D1-D6} is the operating current of D1-D6.

4) Selecting of V_{mode} and Divider Resistor

SP6683 can automatically change from X1 mode to X1.5 mode for highest efficiency. To use this feature, divider resistors should be chosen according to the specific application. The guideline for divider resistor selections is as follows. For high input voltage, the SP6683 will work in X1 mode, when the input voltage drops to V_{th} threshold voltage, it will switch to X1.5 mode automatically. The V_{th} threshold voltage for mode change can be calculated by (3)

$$V_{th} = (V_F + 0.3 + m \cdot I_{LED} \cdot R_{out}) \quad (3)$$

Where V_F and m are the forward voltage and number of the white LEDs, R_{out} is the output resistance of the SP6683.

The equation for the voltage divider R_1 and R_2 with $V_{mode}=1.25V$ is:

$$V_{th} = 1.25V \cdot (1 + R_1/R_2) \quad (4)$$

which can be expressed as R_1 :

$$R_1 = (V_{th}/1.25 - 1) \cdot R_2 \quad (5)$$

For the typical Sp6683 Evaluation Board, using $V_F=3V$, $m=4$, $I_{LED}=15mA$, $R_{out}=6ohms$, the V_{th} will be 3.7V. Select $R_2=100kohm$, then $R_1=192kohm$.

5) Selecting of Capacitors

Ceramic capacitors are used on the evaluation board due to their inherently low ESR, which will help produce low peak to peak output ripple, and reduce high frequency spikes.

Selection of the flying capacitor is a trade-off between the output voltage ripple and the output current capability. Decreasing the flying capacitor will reduce the output voltage ripple because less charge will be delivered to the output capacitor. However, smaller flying capacitor leads to larger output resistance, thus decrease the output current capability and the circuit efficiency.

In the evaluation board, the input, output and flying capacitors are selected as 1uF ceramic capacitors. Input and output ripple could be further reduced by using larger low ESR input and output capacitor.

6) Brightness Control

Obvious dimming control could be achieved by applying a PWM control signal to the ENABLE/PWM pin. The brightness of the white LEDs is controlled by increasing and decreasing the duty cycle of The PWM signal. The recommend frequency range of the PWM signal is from 60Hz to 700Hz. A repetition rate of at least 60Hz is required to prevent flicker.

POWER SUPPLY DATA

For a 4x15mA White LEDs application, in which the output current is 60mA, the power supply data is provided as Fig 1 to Fig 3. The white LEDs used here were from LUMEX (Part Number SML-LX2832UWC-TR). Figure 1 shows the input and output voltage ripple when the input voltage is 3.9V (SP6683 is in X1 mode), Figure 2 shows the input and output voltage ripple when the input voltage is 3.3V (SP6683 is in X1.5 mode). Figure 3 shows the typical efficiency curve in the input voltage range. Channel 1 is the input ripple and the channel 2 is the output ripple. Other applications, such as 80mA output current application (4 20mA white LEDs in parallel), have the similar characteristic.

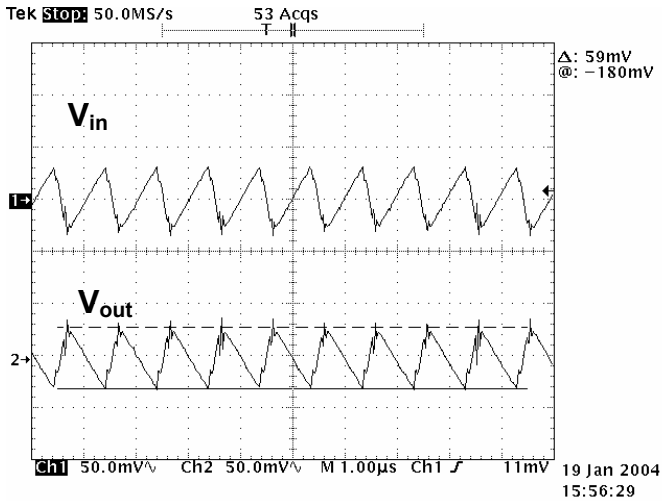

Figure 1. X1 Mode Voltage Ripple @ 3.9V

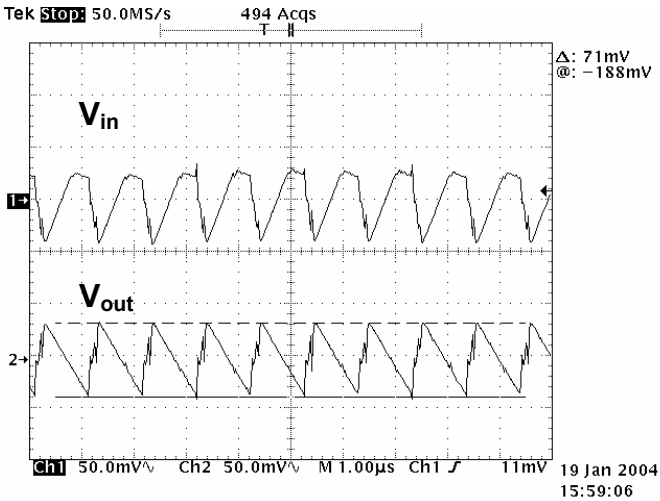

Figure 2. X1.5 Mode Voltage Ripple @ 3.3V

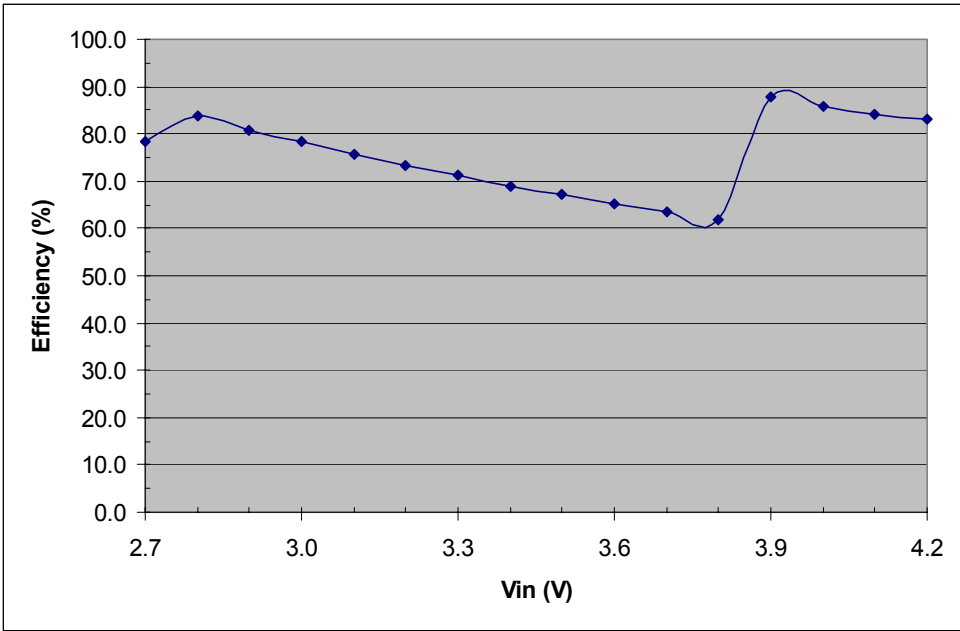

Figure 3. Efficiency vs Input Voltage

Evaluation Board Layout

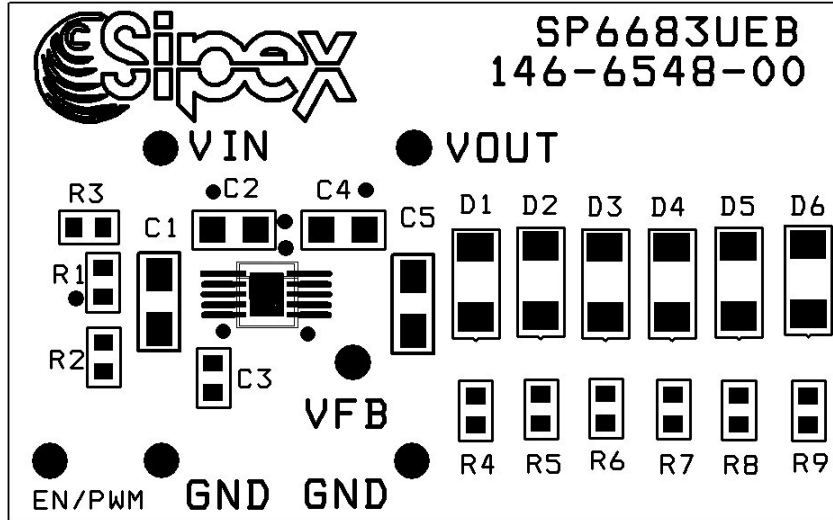

FIGURE 4: SP6683 COMPONENT PLACEMENT

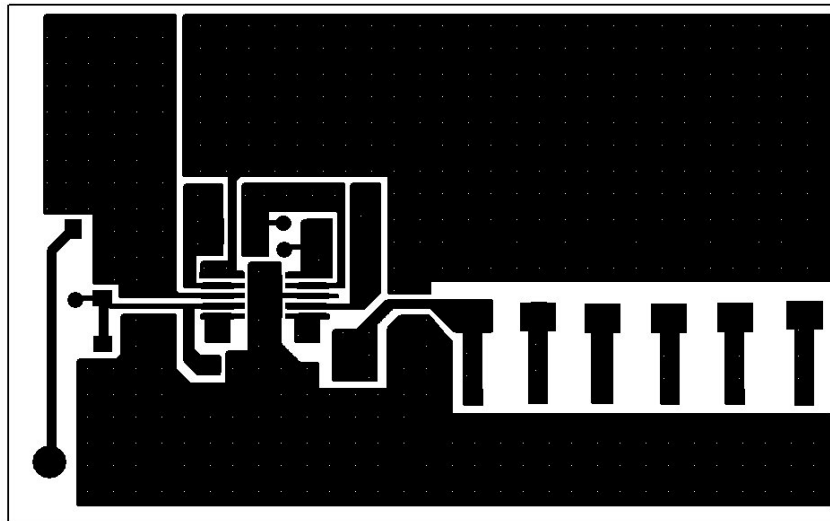

FIGURE 5: SP6683 PC LAYOUT TOP SIDE

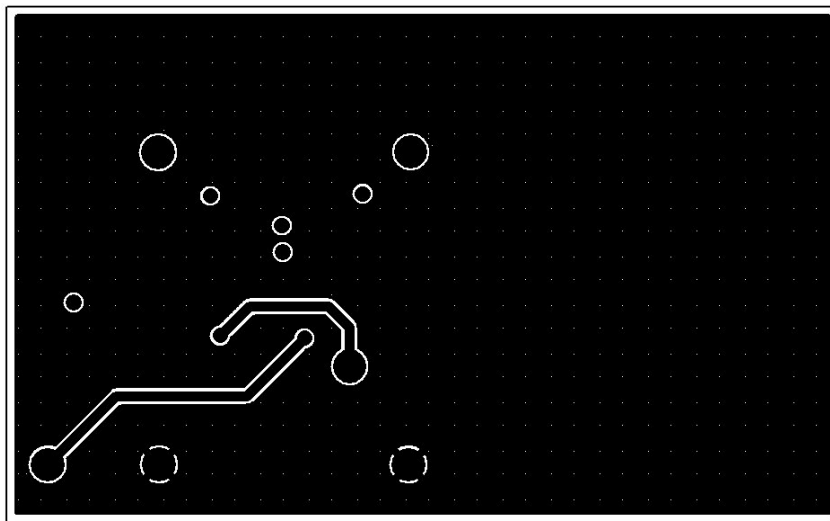

FIGURE 6: SP6683 PC LAYOUT BOTTOM SIDE

TABLE1: SP6683 BILL OF MATERIALS

SP6683 Evaluation Board List of Materials						
Ref. Des.	Qty.	Manufacturer	Part Number	Layout Size LxWxH	Component	Vendor
	1	Sipex Corp.		1"x1.6"	SP6683 Eval PC Board, 146-6548-00	Sipex 978-667-8700
U1	1	Sipex Corp.	SP6683ER	DFN-10	10 PIN High Efficiency Charge Pump Regulator	Sipex 978-667-8700
C1,C2,C4,C5	4	TDK Corp	TDKC1608X5R1A105K	603	1uF/10V/X5R/10% Ceramic	TDK 847-803-6100
C3	2	TDK Corp	TDKC1608X7R1E104K	603	0.1uF/10V/X7R/10% Ceramic	TDK 847-803-6100
D1-D6					Open	
R1	1			603	191K/ 63mW/1%	800-Digi-Key
R2	1			603	100K/ 63mW/1%	800-Digi-Key
R3	1			603	1.0M/ 63mW/5%	800-Digi-Key
R4-R9				603	20Ohms/63mV/1%	800-Digi-Key
TP	6	Mill-Max	0300-115-01-4727100	.042 Dia	Test Point Female Pin	800-Digi-Key

ORDERING INFORMATION

Model	Temperature Range	Package Type
SP6683UEB	-40°C to +85°C.....	SP6683 Evaluation Board
SP6683ER.....	-40°C to +85°C.....	10-pin DFN