



MIC23451 Evaluation Board

3MHz PWM Triple 2A Buck Regulator with
HyperLight Load[®] and Power Good

General Description

This board allows the customer to evaluate the MIC23451, a fully-integrated, triple-output, 2A, 3MHz switching regulator that features HyperLight Load[®] mode and Power Good output indicators. The MIC23451 is highly efficient throughout the output current range, drawing just 24 μ A of quiescent current for each channel in operation. The tiny 4mm x 4mm DFN package saves precious board space and requires few external components. The MIC23451 provides accurate output voltage regulation under the most demanding conditions, with each channel responding extremely quickly to a load transient with exceptionally small output voltage ripple.

Requirements

This board needs a single 20W bench power source adjustable from 2.7V to 5.5V. The loads can be either active (electronic load) or passive (resistor), and must be able to dissipate 10W. It is ideal, but not essential, to have an oscilloscope available to view the circuit waveforms. The simplest tests require two voltage meters to measure input and output voltage. Efficiency measurements for a single channel require two voltage meters and two ammeters to prevent errors caused by measurement inaccuracies.

Precautions

There is no reverse input protection on this board. Be careful when connecting the input source to make sure correct polarity is observed.

Datasheets and support documentation are available on Micrel's web site at: www.micrel.com.

Getting Started

1. Connect an external supply to the V_{IN} (J1) terminal and GND (J2).

With the output of the power supply disabled, set its voltage to the desired input test voltage ($2.7V \leq V_{IN} \leq 5.5V$). An ammeter may be placed between the input supply and the V_{IN} (J1) terminal. Be sure to monitor the supply voltage at the V_{IN} (J1) terminal, as the ammeter and/or power lead resistance can reduce the voltage supplied to the device.

2. Connect a load to the V_{OUT} terminals (J6, J7, J8) and ground (J3, J4, J5) terminals.

The load can be either passive (resistive) or active (electronic load). An ammeter may be placed between the loads and the output terminals. Make sure the output voltage is monitored at the V_{OUT} (J6, J7, J8) terminals.

3. Enable the MIC23451.

The MIC23451 evaluation board has a pull-up resistor to V_{IN} for each channel. By default, each output voltage is enabled when an input supply of >2.7V is applied. To disable the device, apply a voltage below 0.4V to the EN (J10, J12, J14) terminals.

4. Power Good.

The board provides a Power Good test point (J9, J11, J13) to monitor the Power Good function for each individual channel. The Power Good output goes high (V_{OUT}) approximately 60 μ s after the output voltage reaches 90% of its nominal voltage.

Ordering Information

Part Number	Description
MIC23451-AAAYFL EV	Adjustable Output Evaluation Board

Evaluation Board

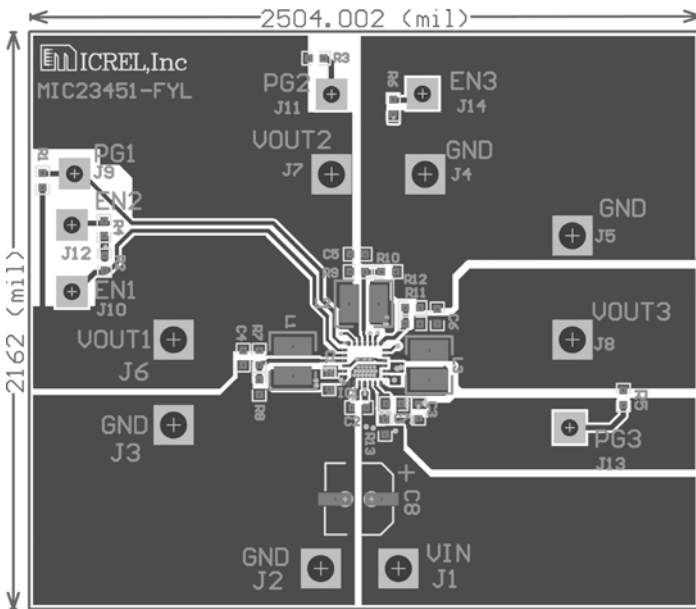

Other Features

Soft-Start Capacitor

The MIC23451 has an internal soft-start for each individual channel and requires no external soft start-capacitor. The typical soft-start time for each channel is 150µs.

Feedback Resistors (R7–R12)

The feedback (FB) pin is the control input for programming the output voltage. A resistor divider network is connected to this pin from the output and is compared to the internal 0.62V reference within the regulation loop. The output voltage can be programmed between 1V and 3.3V using Equation 1:

$$V_{OUT} = V_{REF} \times \left(1 + \frac{R7}{R8}\right) \quad \text{Eq. 1}$$

Where: R7 is the top, V_{OUT} connected resistor, and R8 is the bottom, AGND connected resistor.

Table 1. Example Feedback Resistor Values

V _{OUT}	R7	R8
1.2V	274kΩ	294kΩ
1.5V	316kΩ	221kΩ
1.8V	301kΩ	158kΩ
2.5V	324kΩ	107kΩ
3.3V	309kΩ	71.5kΩ

Power Good (PG)

The evaluation board has a test point for each individual channel to monitor the PG signal. This is an open-drain connection to the output voltage with an on-board pull-up resistor of 10kΩ. This is asserted high approximately 60µs after the output voltage passes 90% of the nominal set voltage.

HyperLight Load Mode

MIC23451 uses a minimum on and off time proprietary control loop (patented by Micrel). When the output voltage falls below the regulation threshold, the error comparator begins a switching cycle that turns the PMOS on and keeps it on for the duration of the minimum-on-time. This increases the output voltage. If the output voltage is over the regulation threshold, the error comparator turns the PMOS off for a minimum-off-time until the output drops below the threshold. The NMOS acts as an ideal rectifier that conducts when the PMOS is off. Using an NMOS switch instead of a diode allows for lower voltage drop across the switching device when it is on. The asynchronous switching combination between the PMOS and the NMOS allows the control loop to work in discontinuous mode for light load operations. In discontinuous mode, the MIC23451 works in pulse frequency modulation (PFM) to regulate the output. As the output current increases, the off-time decreases, which provides more energy to the output. This switching scheme improves the efficiency of MIC23451 during light load currents by switching only when it is needed. As the load current increases, the MIC23451 goes into continuous conduction mode (CCM) and switches at a frequency centered at 3MHz. The equation to calculate the load when the MIC23451 goes into continuous conduction mode is approximated by Equation 2:

$$I_{LOAD} > \left(\frac{(V_{IN} - V_{OUT}) \times D}{2L \times f} \right) \quad \text{Eq. 2}$$

Equation 2 shows that the load at which MIC23451 transitions from Hyper Light Load mode to PWM mode is a function of the input voltage (V_{IN}), output voltage (V_{OUT}), duty cycle (D), inductance (L), and frequency (f). The “Switching Frequency vs. Load” graph in the “Evaluation Board Performance” section shows that, as the output current increases, the switching frequency also increases until the MIC23451 goes from Hyper Light Load mode to PWM mode at approximately 120mA. The MIC23451 will switch at a relatively constant frequency around 3MHz after the output current is over 120mA.

Evaluation Board Performance

Switching Frequency vs. Load Current

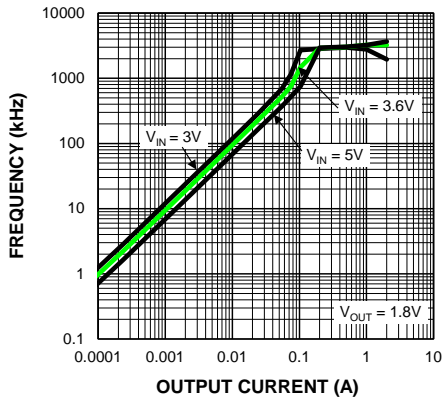

**Efficiency vs. Output Current
V_{OUT} = 2.5V**

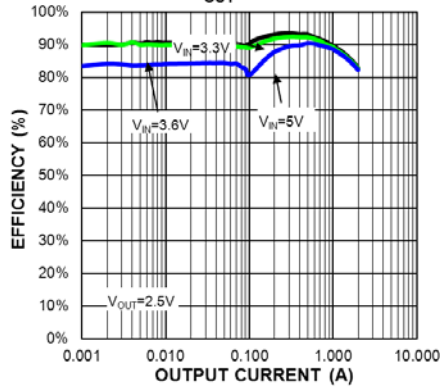

**Efficiency vs. Output Current
V_{OUT} = 1.8V**

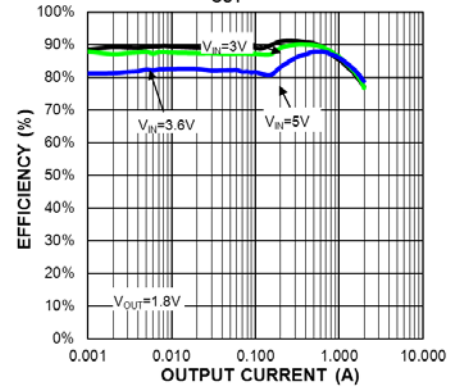

PG Thresholds vs. Input Voltage

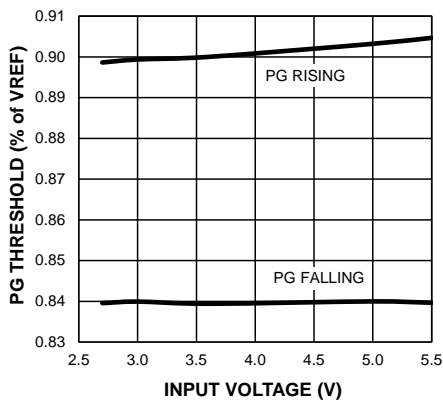

Enable Threshold vs. Input Voltage

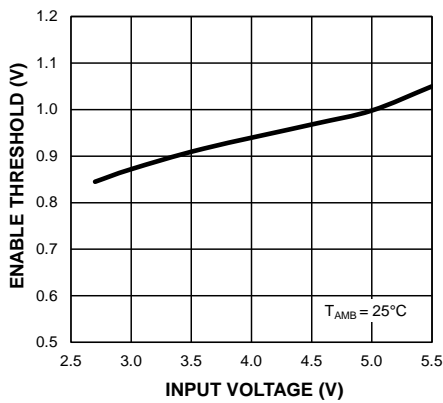

UVLO Threshold vs. Temperature

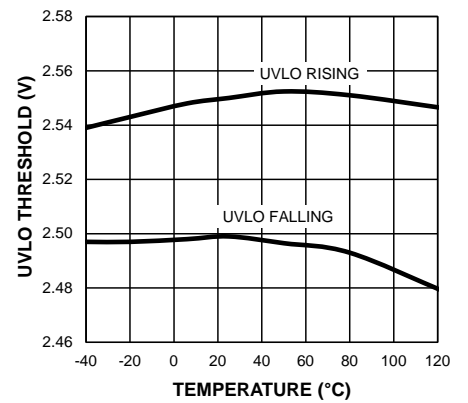

VFB vs. Temperature

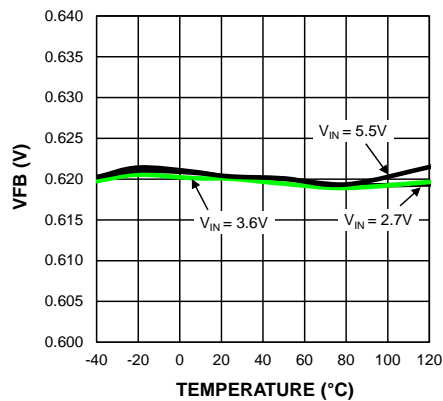

Line Regulation (Low Loads)

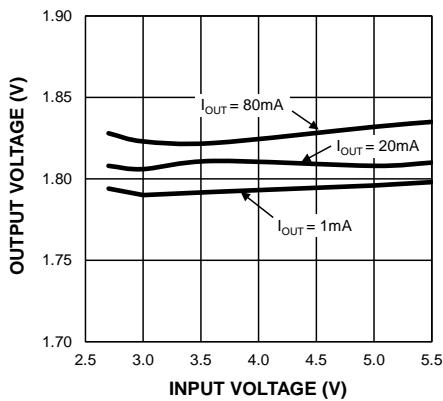

Line Regulation (High Loads)

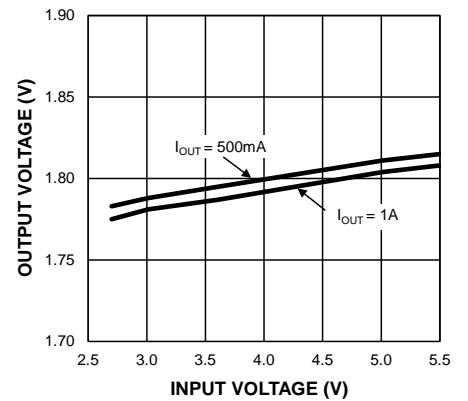

Evaluation Board Schematic

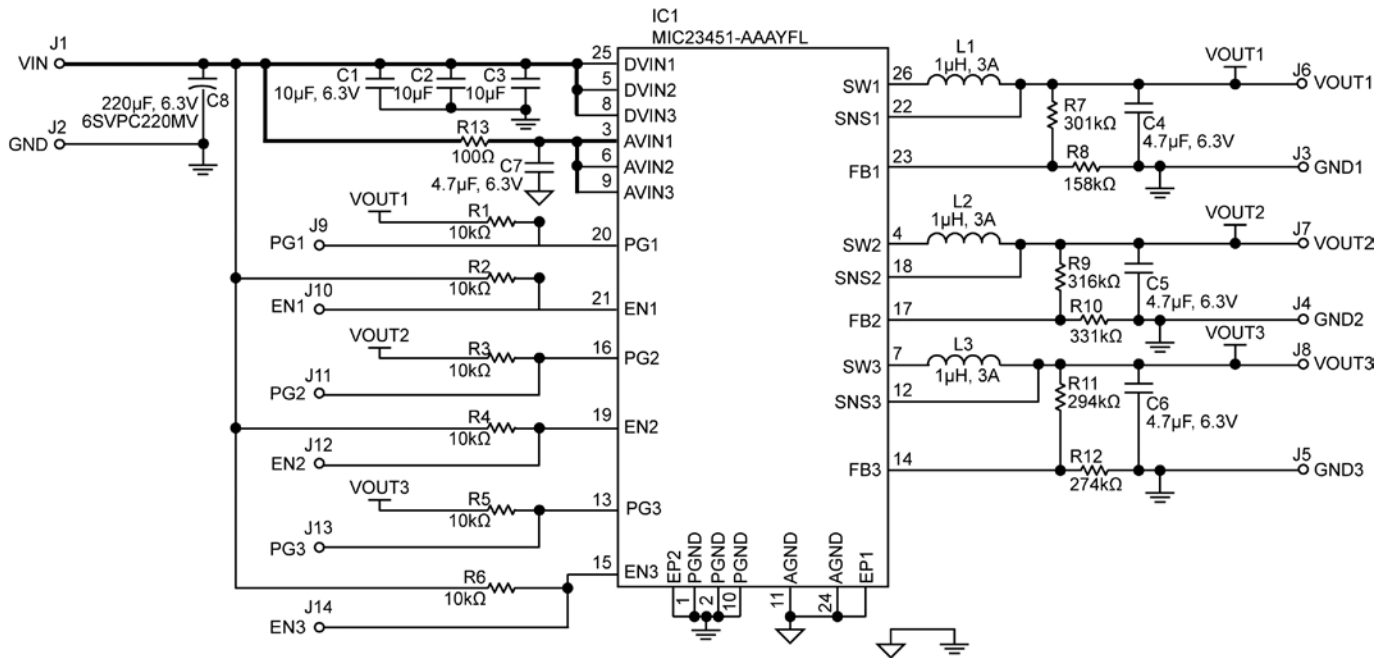

Bill of Materials

Item	Part Number	Manufacturer	Description	Qty.
C1, C2, C3	GRM188R60J106KE19D	Murata ⁽¹⁾	Capacitor, 10µF, Size 0603	3
C4, C5, C6, C7	C1608X5R0J475K	TDK ⁽²⁾	Capacitor, 4.7µF, Size 0603	4
	GRM188R60J475KE19D	Murata		
C8	EEUFR1A221	Panasonic ⁽³⁾	Electrolytic Capacitor, 220µF, 10V, Size 6.3mm	
R1, R2, R3, R4, R5, R6	CRCW060310K0FKEA	Vishay ⁽⁴⁾	Resistor, 10kΩ, Size 0603	6
R7	CRCW0603301K0FKEA	Vishay	Resistor, 301kΩ, Size 0603	1
R8	CRCW0603158K0FKEA	Vishay	Resistor, 158kΩ, Size 0603	1
R9	CRCW0603316K0FKEA	Vishay	Resistor, 316Ω, Size 0603	1
R10	CRCW0603331K0FKEA	Vishay	Resistor, 331kΩ, Size 0603	1
R11	CRCW0603294K0FKEA	Vishay	Resistor, 294kΩ, Size 0603	1
R12	CRCW0603274K0FKEA	Vishay	Resistor, 274kΩ, Size 0603	1
L1, L2, L3	VLS3012ST-1R0N1R9	TDK	1µH, 2A, 60mΩ, L3.0mm x W3.0mm x H1.0mm	3
	LQH44PN1R0NJ0	Murata	1µH, 2.8A, 50mΩ, L4.0mm x W4.0mm x H1.2mm	
U1	MIC23451-AAAYFL	Micrel, Inc. ⁽⁵⁾	3MHz PWM 2A Buck Regulator with HyperLight Load	1

Notes:

1. Murata: www.murata.com.
2. TDK: www.tdk.com.
3. Panasonic: www.industrial.panasonic.com.
4. Vishay: www.vishay.com.
5. Micrel, Inc.: www.micrel.com

PCB Layout Recommendations

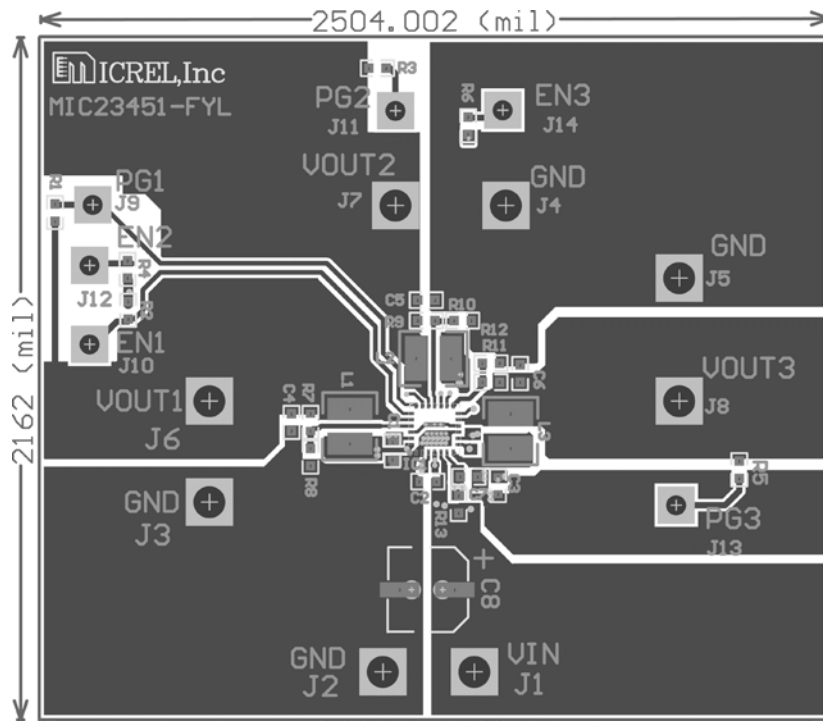

Top Layer

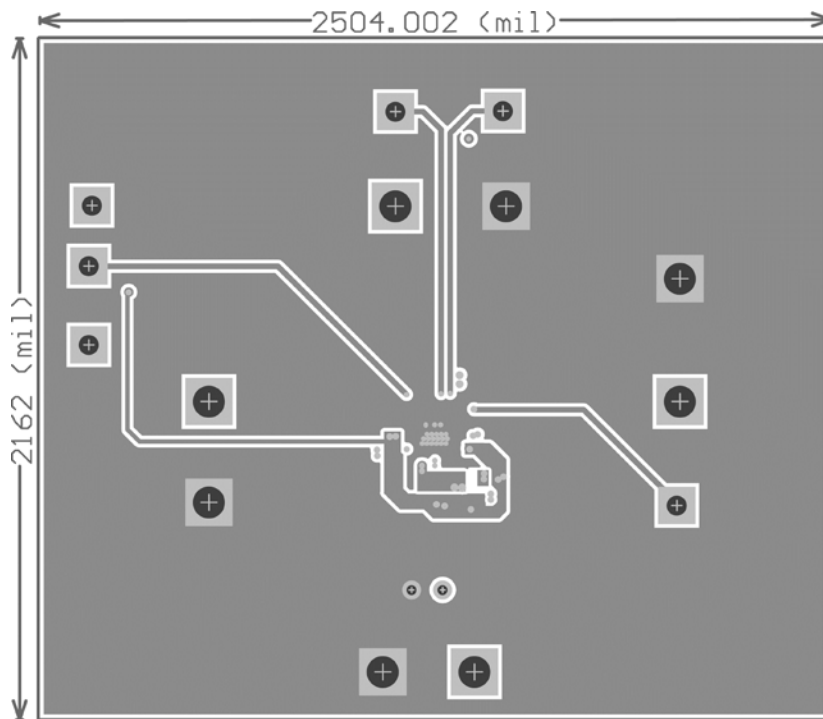

Layer 2

PCB Layout Recommendations (Continued)

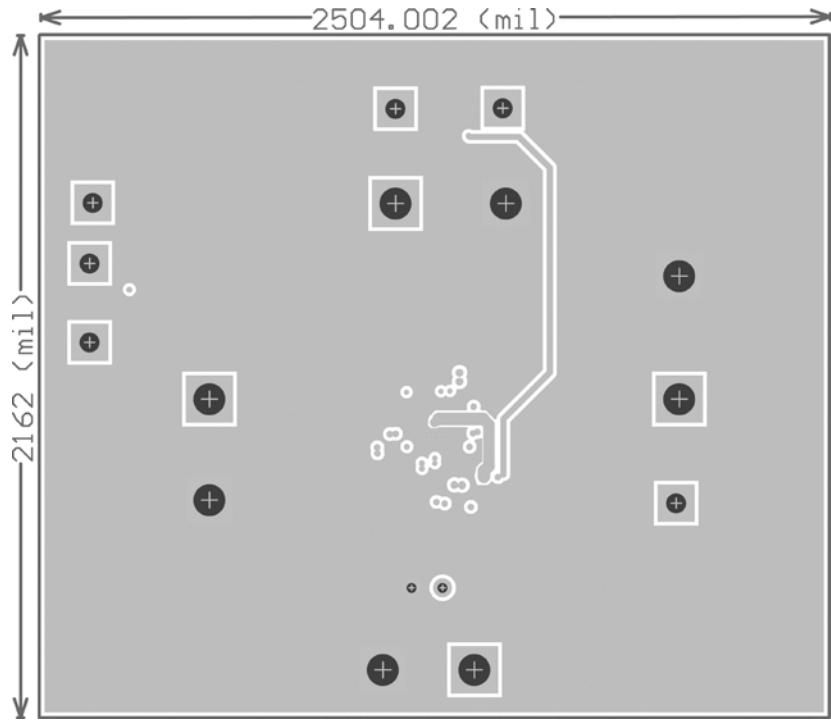

Layer 3

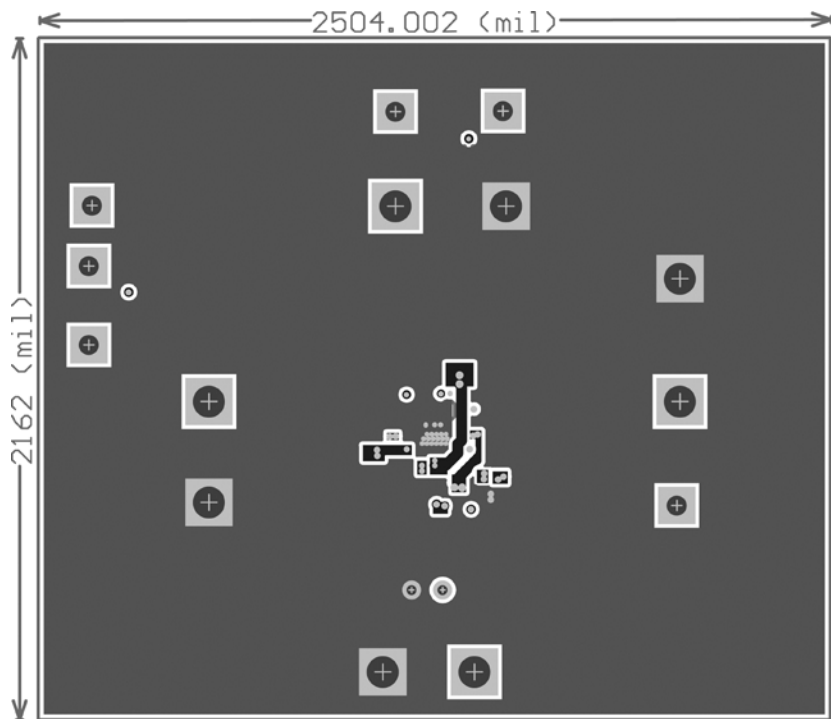

Bottom Layer

MICREL, INC. 2180 FORTUNE DRIVE SAN JOSE, CA 95131 USA
TEL +1 (408) 944-0800 FAX +1 (408) 474-1000 WEB <http://www.micrel.com>

Micrel makes no representations or warranties with respect to the accuracy or completeness of the information furnished in this data sheet. This information is not intended as a warranty and Micrel does not assume responsibility for its use. Micrel reserves the right to change circuitry, specifications and descriptions at any time without notice. No license, whether express, implied, arising by estoppel or otherwise, to any intellectual property rights is granted by this document. Except as provided in Micrel's terms and conditions of sale for such products, Micrel assumes no liability whatsoever, and Micrel disclaims any express or implied warranty relating to the sale and/or use of Micrel products including liability or warranties relating to fitness for a particular purpose, merchantability, or infringement of any patent, copyright or other intellectual property right.

Micrel Products are not designed or authorized for use as components in life support appliances, devices or systems where malfunction of a product can reasonably be expected to result in personal injury. Life support devices or systems are devices or systems that (a) are intended for surgical implant into the body or (b) support or sustain life, and whose failure to perform can be reasonably expected to result in a significant injury to the user. A Purchaser's use or sale of Micrel Products for use in life support appliances, devices or systems is a Purchaser's own risk and Purchaser agrees to fully indemnify Micrel for any damages resulting from such use or sale.

© 2013 Micrel, Incorporated.