

# **eZdsp<sup>TM</sup> F28335**

*Technical  
Reference*



eZdsp™ F28335  
Technical Reference

510195-0001 Rev. C  
November 2007

**SPECTRUM DIGITAL, INC.**  
12502 Exchange Dr., Suite 440 Stafford, TX. 77477  
Tel: 281.494.4505 Fax: 281.494.5310  
sales@spectrumdigital.com www.spectrumdigital.com

### **IMPORTANT NOTICE**

Spectrum Digital, Inc. reserves the right to make changes to its products or to discontinue any product or service without notice. Customers are advised to obtain the latest version of relevant information to verify data being relied on is current before placing orders.

Spectrum Digital, Inc. warrants performance of its products and related software to current specifications in accordance with Spectrum Digital's standard warranty. Testing and other quality control techniques are utilized to the extent deemed necessary to support this warranty.

Please be aware, products described herein are not intended for use in life-support appliances, devices, or systems. Spectrum Digital does not warrant, nor is it liable for, the product described herein to be used in other than a development environment.

Spectrum Digital, Inc. assumes no liability for applications assistance, customer product design, software performance, or infringement of patents or services described herein. Nor does Spectrum Digital warrant or represent any license, either express or implied, is granted under any patent right, copyright, or other intellectual property right of Spectrum Digital, Inc. covering or relating to any combination, machine, or process in which such Digital Signal Processing development products or services might be or are used.

### **WARNING**

This equipment is intended for use in a laboratory test environment only. It generates, uses, and can radiate radio frequency energy and has not been tested for compliance with the limits of computing devices pursuant to subpart J of part 15 of FCC rules, which are designed to provide reasonable protection against radio frequency interference. Operation of this equipment in other environments may cause interference with radio communications, in which case the user, at his own expense, will be required to take any measures necessary to correct this interference.

### **TRADEMARKS**

**eZdsp** is a trademark of Spectrum Digital, Inc.

# Contents

---

---

<b>1</b>	<b>Introduction to the eZdsp™ F28335</b> .....	<b>1-1</b>
	<i>Provides a description of the eZdsp™ F28335, key features, and board outline.</i>	
1.0	Overview of the eZdsp™ F28335 .....	1-2
1.1	Key Features of the eZdsp™ F28335 .....	1-3
1.1.1	Hardware Features .....	1-3
1.1.2	Software Features .....	1-3
1.2	Functional Overview of the eZdsp™ F28335 .....	1-4
<b>2</b>	<b>Operation of the eZdsp™ F28335</b> .....	<b>2-1</b>
	<i>Describes the operation of the eZdsp™ F28335. Information is provided on the eZdsp's various interfaces.</i>	
2.0	The eZdsp™ F28335 Operation .....	2-3
2.1	The eZdsp™ F28335 Board .....	2-3
2.1.1	Power Connector .....	2-4
2.2	eZdsp™ F28335 Memory .....	2-5
2.2.1	Memory Map .....	2-6
2.3	eZdsp™ F28335 Connectors .....	2-7
2.3.1	P1, JTAG Interface .....	2-8
2.3.2	P2, Expansion Interface .....	2-9
2.3.3	P4,P8,P7, I/O Interface .....	2-10
2.3.4	P5,P9, Analog Interface .....	2-12
2.3.5	P6, Power Connector .....	2-13
2.3.6	P10 Expansion Interface .....	2-14
2.3.7	P11, CANA Connector .....	2-15
2.3.8	P12, RS-232 Connector .....	2-16
2.3.9	J11, CANB 5 x 2 Header .....	2-17
2.3.10	J12, SCI-B 5 x 2 Header .....	2-18
2.3.11	J201, Embedded USB JTAG Interface .....	2-18
2.3.12	Connector Part Numbers .....	2-19
2.4	eZdsp™ F28335 Jumpers .....	2-19
2.4.1	JP1, ADCREFIN Select .....	2-20
2.4.2	JR2, XTPD Voltage Select .....	2-20
2.4.3	JR4, Connector P4, P8 Voltage Select .....	2-21
2.4.4	JR5, Connector P2, P10 Voltage Select .....	2-21
2.4.5	JR6, MUX GPIO22_24 Select .....	2-22
2.4.6	JP7, CANA Termination Resistor Select .....	2-22
2.4.7	JP8, CANB Termination Resistor Select .....	2-23
2.5	LEDS .....	2-23

2.6	Switches	2-24
2.6.1	SW1, Boot Load Option Switch	2-23
2.6.2	SW2, Processor Configuration Switch	2-25
2.7	Test Points	2-26
<b>A</b>	<b>eZdsp™ F28335 Schematics</b>	<b>A-1</b>
	<i>Contains the schematics for the eZdsp™ F28335</i>	
<b>B</b>	<b>eZdsp™ F28335 Mechanical Information</b>	<b>B-1</b>
	<i>Contains the mechanical information about the eZdsp™ F28335</i>	

## List of Figures

Figure 1-1, Photo eZdsp™ F28335	1-3
Figure 1-2, Block Diagram eZdsp™ F28335	1-4
Figure 2-1, eZdsp™ F28335 PCB Outline (Top)	2-3
Figure 2-2, eZdsp™ F28335 PCB Outline (Bottom)	2-4
Figure 2-3, eZdsp™ F28335 Memory Space	2-6
Figure 2-4, P1 Pin Locations	2-8
Figure 2-5, Connector P2 Pin Locations	2-9
Figure 2-6, Connector P4/P8/P7 Connectors	2-10
Figure 2-7, Connector P5/P9 Pin Locations	2-12
Figure 2-8, Connector P6 Location	2-13
Figure 2-9, eZdsp™ F28335 Power Connector	2-13
Figure 2-10, Connector P10 Pin Locations	2-14
Figure 2-11, P11, DB9 CANA Female Connector	2-15
Figure 2-12, P12, DB9 RS-232 Female Connector	2-16
Figure 2-13, J11 Pin Locations	2-17
Figure 2-14, J12 Pin Locations	2-18
Figure 2-15, Jumper JP1	2-20
Figure 2-16, Jumper JR2	2-20
Figure 2-17, Jumper JR4	2-21
Figure 2-18, Jumper JR5	2-21
Figure 2-19, Jumper JR6	2-22
Figure 2-20, Jumper JP7	2-22
Figure 2-21, Jumper JP8	2-23
Figure 2-22, SW1, Boot Load Option Switch	2-24
Figure 2-23, SW2, Processor Configuration	2-25
Figure 2-24, eZdsp™ F28335 Test Points (Bottom)	2-26

## List of Tables

Table 2-1, External Chip Select and Usages	2-5
Table 2-2, eZdsp™ F28335 Connectors	2-7
Table 2-3, P1, JTAG Interface Connector	2-8
Table 2-4, P2, Expansion Interface Connector	2-9
Table 2-5, P4, I/O Connectors	2-10
Table 2-6, P8, I/O Connectors	2-11
Table 2-7, P7, I/O Connector	2-11
Table 2-8, P5/P9, Analog Interface Connector	2-12
Table 2-9, P10, Expansion Interface Connector	2-14
Table 2-10, P11, CANA Pinout	2-15
Table 2-11, P12, P12, RS-232 Pinout	2-16
Table 2-12, J11, 5 x 2 Pinout	2-17
Table 2-13, J12, 5 x 2 Pinout	2-18
Table 2-14, J201, Embedded USB JTAG Interface	2-18
Table 2-15, eZdsp™ F28335 Suggested Connector Part Numbers	2-19
Table 2-16, eZdsp™ F28335 Jumpers	2-19
Table 2-17, JP1, U29, Pin 2 to ADCREFIN Select	2-20
Table 2-18, JR2, XTPD Voltage Select	2-20
Table 2-19, JR4, Connector P4, P8 Voltage Select	2-21
Table 2-20, JR5, Connector P2, P10 Voltage Select	2-21
Table 2-21, JR6, MUX GPIO22 Select	2-22
Table 2-22, JP7, CANA Termination Resistor Select	2-22
Table 2-23, JP8, CANA Termination Resistor Select	2-23
Table 2-24, LEDs	2-23
Table 2-25, SW1, Boot Load Option Switch	2-24
Table 2-26, SW2, Processor Configuration Switch	2-25
Table 2-27, Test Points	2-25



## About This Manual

This document describes board level operations of the eZdsp™ F28335 based on the Texas Instruments TMS320F28335 Digital Signal Controller (DSC).

The eZdsp™ F28335 is a stand-alone module permitting engineers and software developers evaluation of certain characteristics of the TMS320F28335 DSC to determine processor applicability to design requirements. Evaluators can create software to execute onboard or expand the system in a variety of ways.

## Notational Conventions

This document uses the following conventions.

The “eZdsp™ F28335” will sometimes be referred to as the “eZdsp”.

“eZdsp” will include the socketed or unsocket version

Program listings, program examples, and interactive displays are shown in a special italic typeface. Here is a sample program listing.

```
equations  
!rd = !strobe&rw;
```

## Information About Cautions

This book may contain cautions.

***This is an example of a caution statement.***

A caution statement describes a situation that could potentially damage your software, hardware, or other equipment. The information in a caution is provided for your protection. Please read each caution carefully.

## Related Documents

Texas Instruments TMS320F28335 Digital Signal Controllers Data Manual,  
literature #SPRS439

Texas Instruments TMS320C28x DSP CPU and Instruction Set Reference Guide,  
literature #SPRU430

Texas Instruments TMS320C28x Assembly Language Tools Users Guide,  
literature #SPRU513

Texas Instruments TMS320C28x Optimizing C/C++ Compiler User's Guide,  
literature #SPRU514

Texas Instruments Code Composer Studio Getting Started Guide,  
literature #SPRU509

**Table 1: Manual History**

Revision	History
A	Production Release
B	Updated Figures, Text, Schematics
C	Updated Figures, Tables, Text

**Table 2: Board History**

PWB Revision	History
A	Production Release
B	Updated Silk-screen

# Chapter 1

## Introduction to the eZdsp™ F28335

---

---

---

This chapter provides a description of the eZdsp™ for the TMS320F28335 Digital Signal Controller, key features, and block diagram of the circuit board.

Topic	Page
1.0 Overview of the eZdsp™ F28335	1-2
1.1 Key Features of the eZdsp™ F28335	1-3
1.1.1 Hardware Features	1-3
1.1.2 Software Features	1-3
1.2 Functional Overview of the eZdsp™ F28335	1-4



## **1.1 Key Features of the eZdsp™ F28335**

### **1.1.1 Hardware Features**

The eZdsp™ F28335 has the following features:

- TMS320F28335 Digital Signal Controller
- 150 Mhz. operating speed
- On chip 32-bit floating point unit
- 68K bytes on-chip RAM
- 512K bytes on-chip Flash memory
- 256K bytes off-chip SRAM memory
- On chip 12 bit Analog to Digital (A/D) converter with 16 input channels
- 30 MHz. input clock
- On board RS-232 connector with line driver
- On board CAN 2.0 interface with line driver and connector
- Multiple Expansion Connectors (analog, I/O)
- On board embedded USB JTAG Controller
- 5-volt only operation with supplied AC adapter
- On board IEEE 1149.1 JTAG emulation connector

### **1.1.2 Software Features**

- TI F28xx Code Composer Studio™ Integrated Development Environment, Version 3.3
- Texas Instruments' Flash APIs to support the F28335
- Texas Instruments' F28335 header files and example software

## 1.2 Functional Overview of the eZdsp™ F28335

Figure 1-1 shows a block diagram of the basic configuration for the eZdsp™ F28335. The major interfaces of the eZdsp are the JTAG interface, and expansion interface.

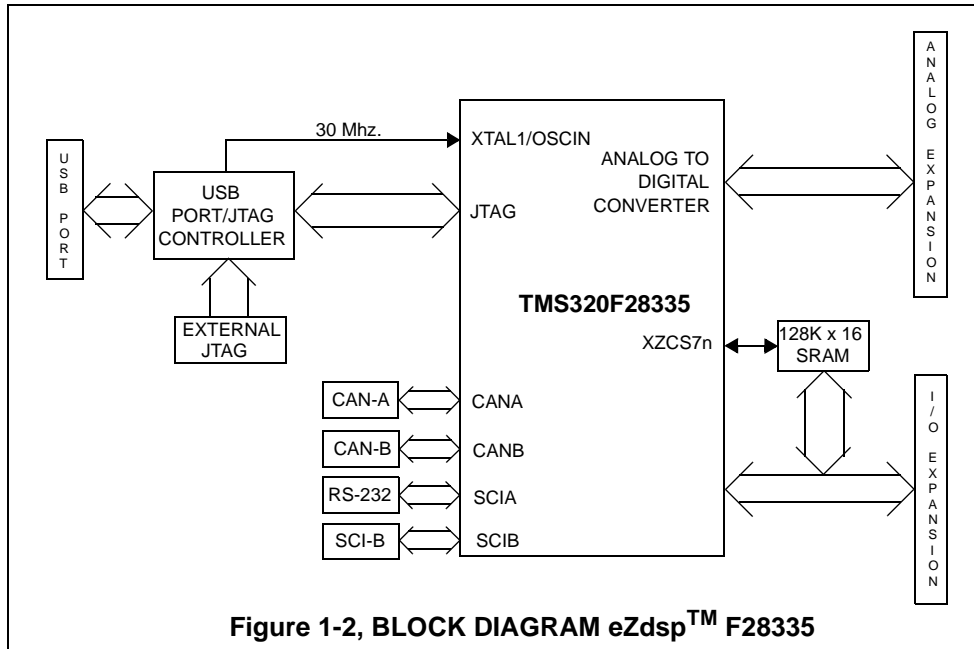

## Chapter 2

# Operation of the eZdsp™ F28335

---

---

This chapter describes the operation of the eZdsp™ F28335, key interfaces and includes a circuit board outline.

<b>Topic</b>	<b>Page</b>
2.0 The eZdsp™ F28335 Operation	2-3
2.1 The eZdsp™ F28335 Board	2-3
2.1.1 Power Connector	2-4
2.2 eZdsp™ F28335 Memory	2-5
2.2.1 Memory Map	2-6
2.3 eZdsp™ F28335 Connectors	2-7
2.3.1 P1, JTAG Interface	2-8
2.3.2 P2, Expansion Interface	2-9
2.3.3 P4/P8/P7, I/O Interface	2-10
2.3.4 P5/P9, Analog Interface	2-12
2.3.5 P6, Power Connector	2-13
2.3.6 P10, Expansion Interface	2-14
2.3.7 P11, CANA Connector	2-15
2.3.8 P12, RS-232 Connector	2-16
2.3.9 J11, CANB 5 x 2 Header	2-17
2.3.10 J12, SCIB 5 x 2 Header	2-18
2.3.11 J201, Embedded USB JTAG Interface	2-18
2.3.12 Connector Part Numbers	2-19

<b>Topic</b>	<b>Page</b>
<b>2.4 eZdsp™ F28335 Jumpers</b>	<b>2-19</b>
<b>2.4.1 JP1, ADCREFIN Select</b>	<b>2-20</b>
<b>2.4.2 JR2, XTPD Voltage Select</b>	<b>2-20</b>
<b>2.4.3 JR4, Connector P4, P8 Voltage Select</b>	<b>2-21</b>
<b>2.4.4 JR5, Connector P2, P10 Voltage Select</b>	<b>2-21</b>
<b>2.4.5 JR6, MUX GPIO22_24 Select</b>	<b>2-22</b>
<b>2.4.6 JP7, CANA Termination Resistor Select</b>	<b>2-22</b>
<b>2.4.7 JP8, CANB Termination Resistor Select</b>	<b>2-23</b>
<b>2.5 LEDs</b>	<b>2-23</b>
<b>2.6 Switches</b>	<b>2-24</b>
<b>2.6.1 SW1, Boot Load Option Switch</b>	<b>2-24</b>
<b>2.6.2 SW2, Processor Configuration Switch</b>	<b>2-25</b>
<b>2.7 Test Points</b>	<b>2-26</b>



## 2.0 The eZdsp™ F28335 Operation

This chapter describes the eZdsp™ F28335, key components, and operation. Information on the eZdsp's various interfaces is also included. The eZdsp™ F28335 consists of four major blocks of logic:

- Analog Interface Connector
- I/O Interface Connector
- On board Memory
- JTAG Interface
- Embedded USB JTAG Controller Interface

## 2.1 The eZdsp™ F28335 Board

The eZdsp™ F28335 is a 5.35 x 3.0 inch, multi-layered printed circuit board, powered by an external 5-Volt only power supply. Figure 2-1 shows the layout of the top side of the F28335 eZdsp.

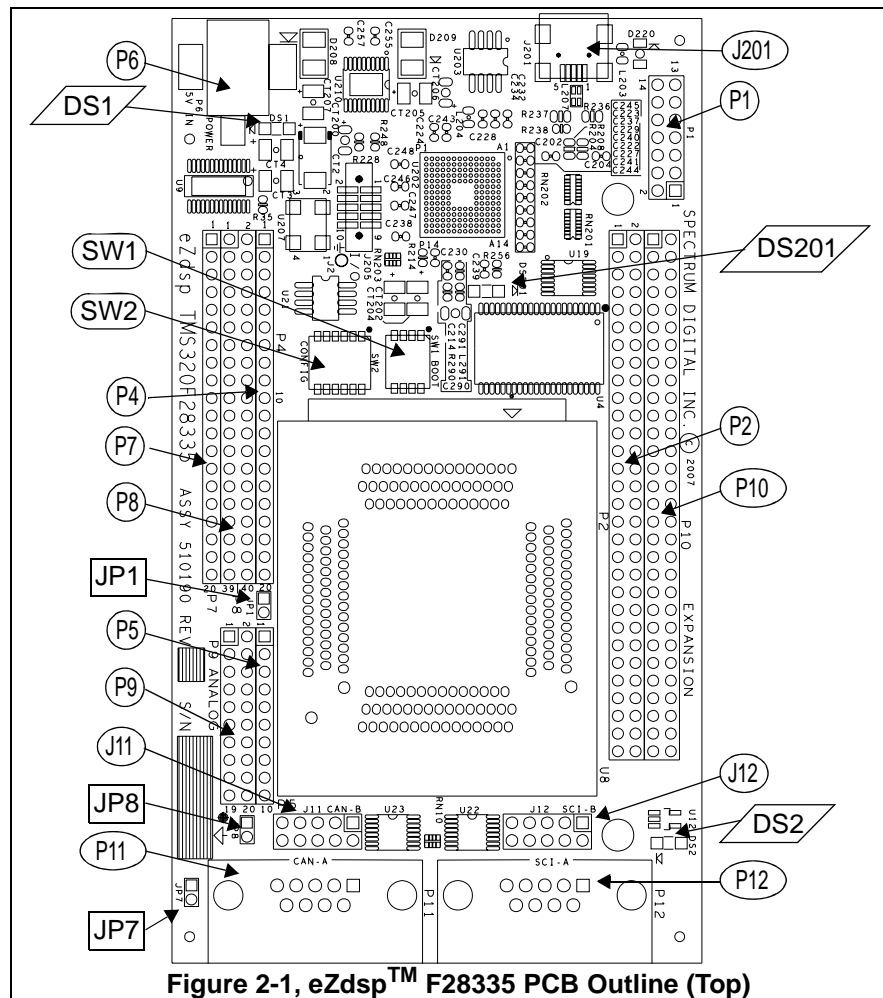
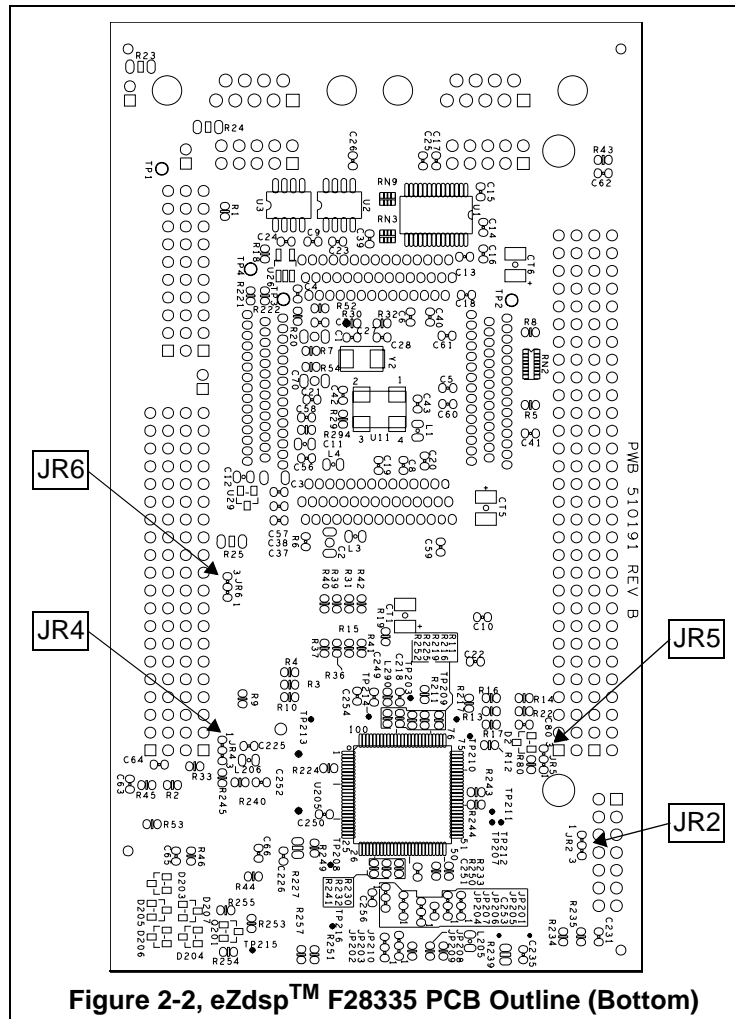

Figure 2-2 shows the layout of the bottom side of the F28335 eZdsp.



### 2.1.1 Power Connector

The eZdsp™ F28335 is powered by a +5 Volt only power supply, included with the unit. The power is supplied via connector P6. If expansion boards are connected to the eZdsp, a higher amperage power supply may be necessary.

## 2.2 eZdsp™ F28335 Memory

The eZdsp includes the following on-chip memory:

- 256K x 16 Flash
- 8 blocks of 4K x 16 single access RAM (SARAM)
- 2 blocks of 8K x 16 SARAM
- 2 blocks of 1K x 16 SARAM

In addition 128K x 16 off-chip SRAM is provided. The processor on the eZdsp can be configured for boot-loader mode or non-boot-loader mode.

The eZdsp can load ram for debug or FLASH ROM can be loaded and run. For larger software projects it is suggested to do a initial debug with on eZdsp F28335 module which supports a total RAM environment. With careful attention to the I/O mapping in the software the application code can easily be ported to the F28335.

The table below shows the external chip select signal and its use.

**Table 1: External Chip Select and Usage**

Chip Select Signal	Use
XZCS0n	Expansion header
XZCS6n	Expansion Header
XZCS7n	External SRAM

### 2.2.1 Memory Map

The figure below shows the memory map configuration on the eZdsp™ F28335.

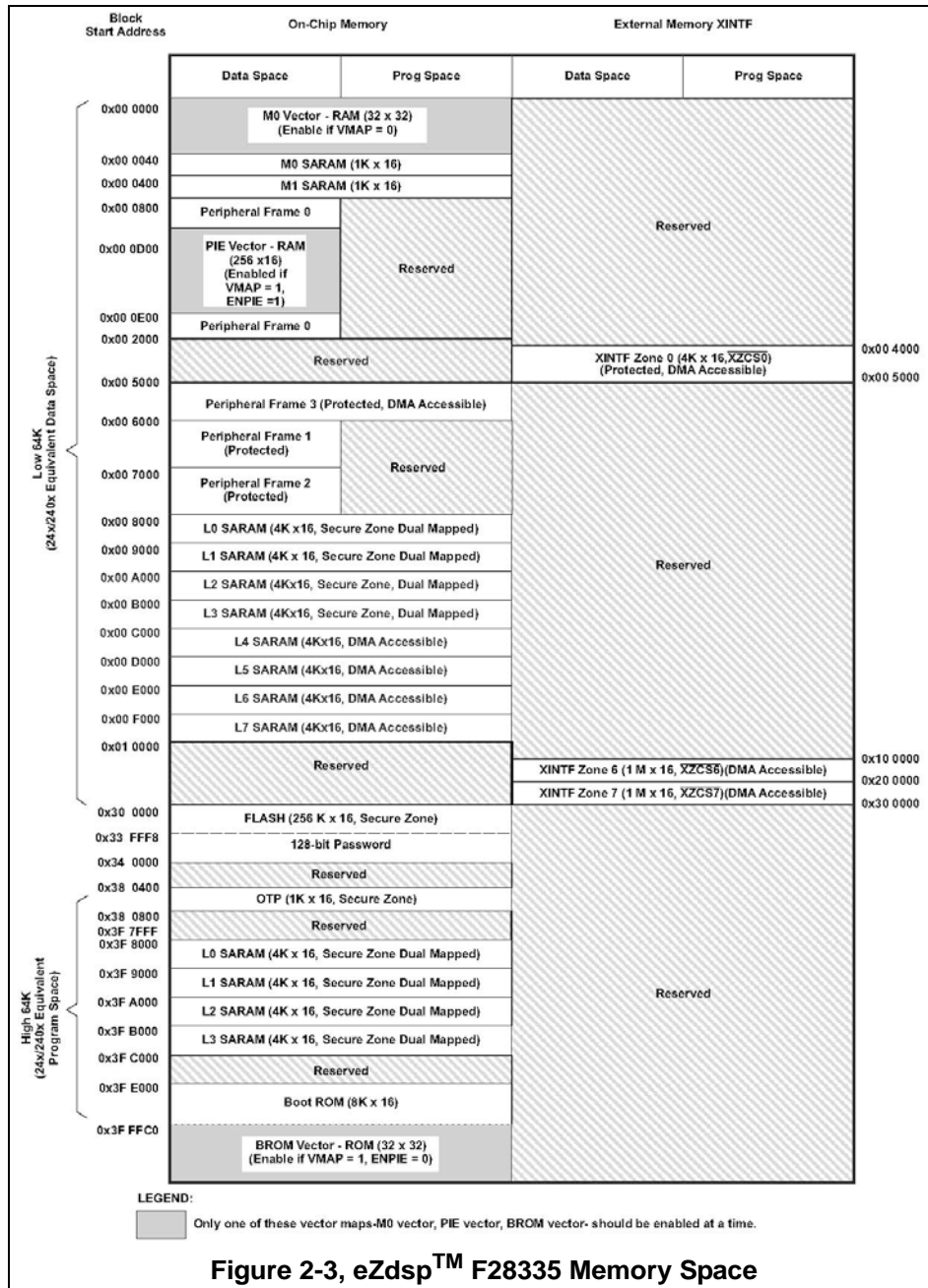

**Note:** The on-chip flash memory has a security key which can prevent visibility when enabled.

### 2.3 eZdsp™ F28335 Connectors

The eZdsp™ F28335 has fourteen connectors. The function of each connector is shown in the table below:

**Table 2: eZdsp™ F28335 Connectors**

Connector	Function
P1	JTAG Interface
P2	Expansion
P4/P8/P7	I/O Interface
P5/P9	Analog Interface
P6	Power Connector
P10	Expansion
P11	CAN-A
P12	SCI-A
J11	CAN-B
J12	SCI-B
J201	Embedded JTAG

### 2.3.1 P1, JTAG Interface

The eZdsp™ F28335 is supplied with a 14-pin header interface, P1. This is the standard interface used by JTAG emulators to interface to Texas Instruments DSPs.

The positions of the 14 pins on the P1 connector are shown in the diagram below as viewed from the top of the eZdsp.

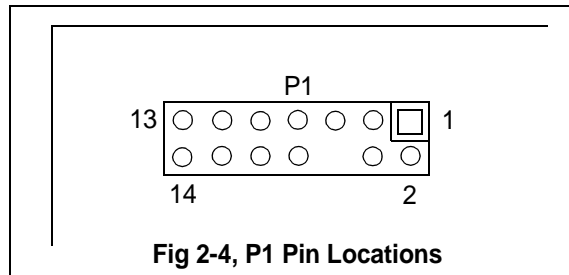

The definition of P1, which has the JTAG signals is shown below.

**Table 3: P1, JTAG Interface Connector**

Pin #	Signal	Pin #	Signal
1	XTMS	2	XTRST-
3	XTDI	4	GND
5	XTPD (+3.3/5V)	6	<b>no pin</b>
7	T_TDO	8	USBSEL
9	T_TCK RET	10	GND
11	XTCK	12	GND
13	T_EMU0	14	T_EMU1

**WARNING !**

The TMS320F28335 supports +3.3V Input/Output levels which are NOT +5V tolerant. Connecting the eZdsp to a system with +5V Input/Output levels will damage the TMS320F28335. If the eZdsp is connected to another target then the eZdsp must be powered up first and powered down last to prevent latchup conditions.

### 2.3.2 P2, Expansion Interface

The positions of the 60 pins on the P2 connector are shown in the figure below.

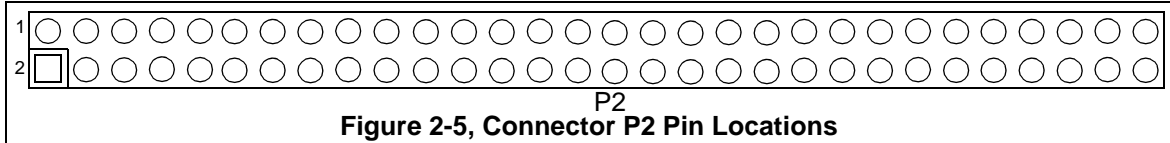

The definition of P2, which has the I/O signal interface is shown below.

**Table 4: P2, Expansion Interface Connector**

Pin #	Signal	Pin #	Signal
1	+3.3V/+5V/NC *	2	+3.3/+5V/NC *
3	GPIO79_XD0	4	GPIO78_XD1
5	GPIO77_XD2	6	GPIO76_XD3
7	GPIO75_XD4	8	GPIO74_XD5
9	GPIO73_XD6	10	GPIO72_XD7
11	GPIO71_XD8	12	GPIO70_XD9
13	GPIO69_XD10	14	GPIO68_XD11
15	GPIO67_XD12	16	GPIO66_XD13
17	GPIO65_XD14	18	GPIO64_XD15
19	GPIO40_XA0_XWE1n	20	GPIO41_XA1
21	GPIO42_XA2	22	GPIO43_XA3
23	GPIO44_XA4	24	GPIO45_XA5
25	GPIO46_XA6	26	GPIO47_XA7
27	GPIO80_XA8	28	GPIO81_XA9
29	GPIO82_XA10	30	GPIO83_XA11
31	GPIO84_XA12	32	GPIO85_XA13
33	GPIO86_XA14	34	GPIO87_XA15
35	GND	36	GND
37	GPIO36_SCIRXDA_XZCS0n	38	GPIO37_ECAP2_XZCS7n
39	GPIO34_ECAP1_XREADY	40	B_GPIO28_SCIRXDA_XZCS6n
41	GPIO35_SCIRXDA_XRNW	42	10K Pull-up
43	GPIO38_WE0n	44	XRDn
45	+3.3V	46	No connect
47	DSP_RS <sub>n</sub>	48	XCLKOUT
49	GND	50	GND
51	GND	52	GND
53	GPIO39_XA16	54	GPIO31_CANTXA_XA17
55	GPIO30_CANRXA_XA18	56	GPIO14_TZ3n_XHOLD <sub>n</sub> _SCITXB_MCLKXB
57	GPIO15_XHOLD <sub>A</sub> <sub>n</sub> _SCIRXDB_MFSXB	58	GPIO29_SCITXDA_XA19
59	No connect	60	No connect

\* Default is No Connect (NC). User can jumper to +3.3V or +5V on backside of eZdsp with JR5.

2.3.3 P4/P8/P7, I/O Interface

The connectors P4, P8, and P7 present the I/O signals from the DSC. The layout of these connectors are shown below.

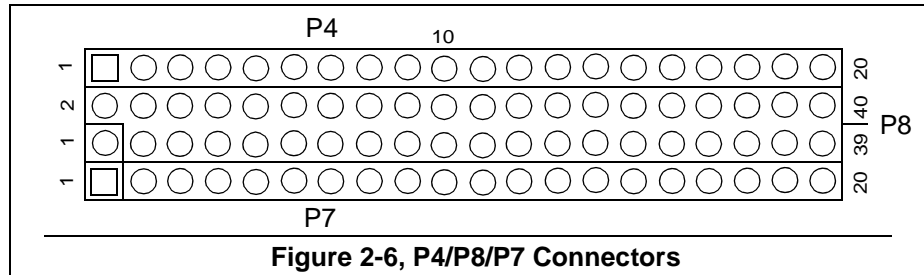

The pin definition of the P4 connector is shown in the table below.

**Table 5: P4, I/O Connectors**

Pin #	Signal
1	+3.3V/+5V/NC *
2	No connect
3	GPIO22_EQEP1S_MCLKRA_SCITXDB
4	GPIO7_EPWM4B_MCLKRA_ECAP2
5	GPIO23_EQEP1_MFSXA_SCIRXDB
6	GPIO5_EPWM3B_MFSRA_ECAP1
7	GPIO20_EAEP1A_MXDA_CANTXB
8	GPIO21_EQEP1B_MDRA_CANRXB
9	No connect
10	GND
11	GPIO3_EPWM2B_ECAP5_MCLKRB
12	GPIO1_EPWM1B/ECAP6/MFSRB
13	No connect
14	No connect
15	No connect
16	No connect
17	No connect
18	GPIO14_TZ3n_XHOLD_SCITXDB_MCLKXB
19	GPIO15_TZ4n_XHOLDA_SCIRXDB_MFSXB
20	GND



The pin definition of the P8 connector is shown in the table below.

**Table 6: P8, I/O Connectors**

Pin #	Signal	Pin #	Signal
1	+3.3V/+5V/NC *	2	+3.3V/+5V/NC *
3	MUX_GPIO29_SCITXDA_XA19	4	MUX_GPIO28_SCIRXDA_XZCS6n
5	GPIO14_TZ3n_XHOLD_SCITXDB_MCLKXB	6	GPIO20_EAEP1A_MXDA_CANTXB
7	GPIO21_EQEP18_MDRA_CANRXB	8	GPIO23_EQEP1_MFSXA_SCIRXDB
9	GPIO0_EPWM1A	10	GPIO1_EPWM1B/ECAP6/MFSRB
11	GPIO2_EPWM2A	12	GPIO3_EPWM2B_ECAP5_MCLKRB
13	GPIO4_EPWM3A	14	GPIO5_EPWM3B_MFSRA_ECAP1
15	GPIO27_ECAP4_EQEP2S_MFSXB	16	GPIO6_EPWMN4A_EPWMSYNCCI/EPWMSYNCO
17	GPIO13_TZ2N_CANRXB_MDRB	18	GPIO34_ECAP1_XREADY
19	GND	20	GND
21	GPIO7_EPWM4B_MCLKRA_ECAP2	22	GPIO15TZ4n_XHOLDA_SCIRXDB_MFSXB
23	GPIO16_SPISIMOA_CANTXB_TZ5n	24	GPIO17_SPISOMIA_CANRXB_TZ6n
25	GPIO18_SPICLKA_SCITXDB_CANRXA	26	GPIO19_SPISTAn_SCIRXDB_CANTXA
27	_MUX_GPIO31_CANRXA_XA17	28	MUX_GPIO30_CANRXA_XA18
29	MUX_GPIO11_EPWM6B_SCIRXDB_ECAP4	30	MUX_GPIO8EPWM5A_CANTXB_ADCSOCA0nP3
31	MUX_GPIO9_EPWM5B_SCITXDB_ECAP3	32	MUX_GPIO10_EPWM6A_CANRXB_ADCASOCB0n
33	MUX_GPIO22	34	GPIO25_ECAP2_EPEQ2B_MDRB
35	GPIO26_ECAP3_EQEP21_MCLKXB	36	GPIO32_SDAA_EPWMSYNCCI_ADCSOCA0n
37	GPIO12_TZ1N_CANTXB_MDXB	38	GPIO33_SCLA_EPWNSYNCOV0_ADCSOCB0n
39	GND	40	GND

\* Default is No Connect (NC). User can jumper to +3.3V or +5V on backside of eZdsp with JR4.

The P7 connector is supplied for backwards compatibility. Signals from other connectors can be wired to this connector to support existing user interfaces. The pin definition of P7 connector is shown in the table below.

**Table 7: P7, I/O Connector**

Pin #	Signal	Pin #	Signal
1	No connect	11	No connect
2	No connect	12	No connect
3	No connect	13	No connect
4	No connect	14	No connect
5	No connect	15	No connect
6	No connect	16	No connect
7	No connect	17	No connect
8	No connect	18	No connect
9	No connect	19	No connect
10	No connect	20	GND

**2.3.4 P5/P9, Analog Interface**

The position of the 30 pins on the P5/P9 connectors are shown in the diagram below as viewed from the top of the eZdsp.

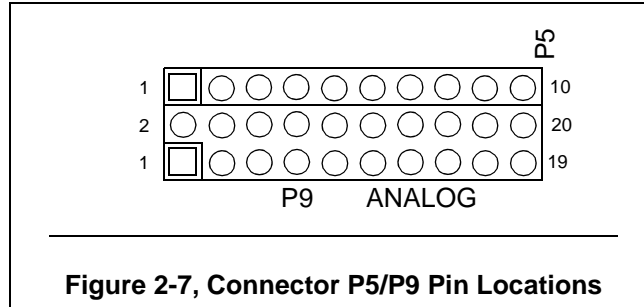

The definition of P5/P9 signals are shown in the table below.

**Table 8: P5/P9, Analog Interface Connector**

P5 Pin #	Signal	P9 Pin #	Signal	P9 Pin #	Signal
1	ADCINB0	1	GND	2	ADCINA0
2	ADCINB1	3	GND	4	ADCINA1
3	ADCINB2	5	GND	6	ADCINA2
4	ADCINB3	7	GND	8	ADCINA3
5	ADCINB4	9	GND	10	ADCINA4
6	ADCINB5	11	GND	12	ADCINA5
7	ADCINB6	13	GND	14	ADCINA6
8	ADCINB7	15	GND	16	ADCINA7
9	ADCREFM	17	GND	18	ADCLO *
10	ADCREFP	19	GND	20	No connect

\* Connect ADCLO to AGND or ADCLO of target system for proper ADC operation.

### 2.3.5 P6, Power Connector

Power (5 volts) is brought onto the eZdsp™ F28335 via the P6 connector. The connector has an outside diameter of 5.5 mm. and an inside diameter of 2.5 mm. The position of the P6 connector is shown below.

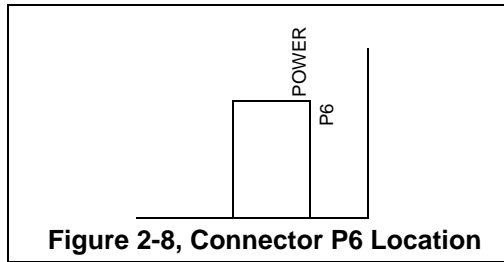

Figure 2-8, Connector P6 Location

The diagram of P6, which has the input power is shown below.

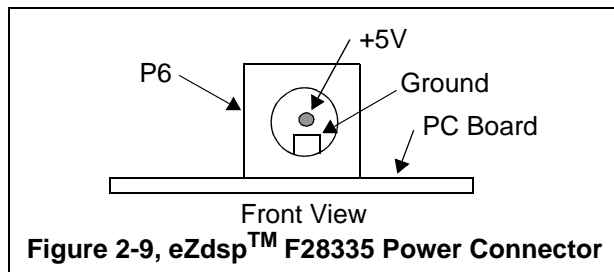
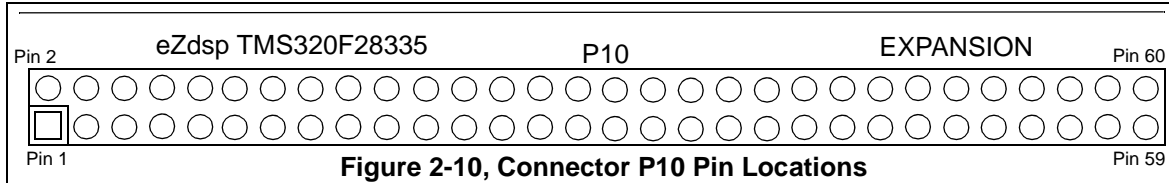

Figure 2-9, eZdsp™ F28335 Power Connector

**2.3.6 P10, Expansion Interface**

The positions of the 60 pins on the P10 connector are shown in the figure below.



**Figure 2-10, Connector P10 Pin Locations**

The definition of P10, which has the I/O signal interface is shown below.

**Table 9: P10, Expansion Interface Connector**

Pin #	Signal	Pin #	Signal
1	+3.3V/+5V/NC	2	+3.3V/+5V/NC
3	GPIO63_SCITXDC_XD16	4	GPIO62_SCIRXDC_XD17
5	GPIO61_MFSRB_XD18	6	GPIO60_MCLKRB_XD19
7	GPIO59_MFSRA_XD20	8	GPIO58_MCLKRA_XD21
9	GPIO57_SPISTEA_XD22	10	GPIO56_SPICLKA_XD23
11	GPIO55_SPISOMIA_XD24	12	GPIO54_SPISIMOA_XD25
13	GPIO53EQEP1_XD26	14	GPIO52_EQEP1S_XD27
15	GPIO51_EAEP1B_XD28	16	GPIO50_EQEP1A_XD29
17	GPIO49_ECAP6_XD30	18	GPIO48_ECAP5_XD31
19	No connect	20	No Connect
21	No connect	22	No Connect
23	No connect	24	No Connect
25	No connect	26	No Connect
27	No connect	28	No Connect
29	No connect	30	No Connect
31	No connect	32	No Connect
33	No connect	34	No Connect
35	No connect	36	No Connect
37	No connect	38	No Connect
39	No connect	40	No Connect
41	No connect	42	No Connect
43	No connect	44	No Connect
45	No connect	46	No Connect
47	No connect	48	No Connect
49	No connect	50	No Connect
51	No connect	52	No Connect
53	No connect	54	No Connect
55	No connect	56	No Connect
57	No connect	58	No Connect
59	GND	60	GND

### 2.3.7 P11, CANA Connector

The eZdsp F28335 has a 9 Pin female D-connector which brings out the CANA transmit and receive signals. This CAN interface uses the SN65HVD235 CAN driver. The pin positions for the P11 connector as viewed from the edge of the printed circuit shown below.

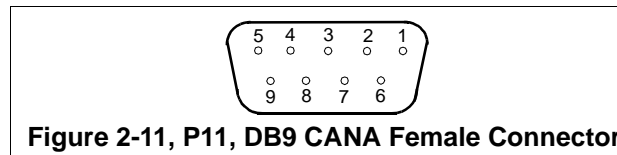

The pin numbers and their corresponding signals are shown in the table below.

**Table 10: P11, CANA Pinout**

Pin #	Signal Name
1	No Connect
2	CANLA
3	GND
4	No Connect
5	No Connect
6	No Connect
7	CANHA
8	No Connect
9	No Connect

### 2.3.8 P12, RS-232 Connector

The eZdsp F28335 has an RS-232 connector which brings out the SCIA transmit and receive signals to be used as UART. This UART uses the MAX3238 RS-232 line driver and is routed to a male 9 pin D-connector, P12. The pin positions for the P10 connector as viewed from the edge of the printed circuit board are shown below.

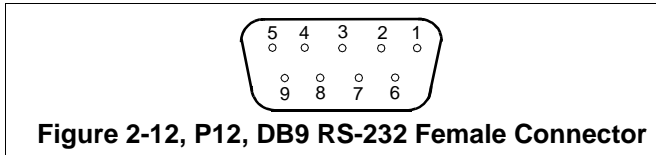

**Figure 2-12, P12, DB9 RS-232 Female Connector**

The pin numbers and their corresponding signals are shown in the table below. This corresponds to a standard dual row to DB-9 connector interface used on personal computers.

**Table 11: P12, RS-232 Pinout**

Pin #	Signal Name	Direction
1	No Connect	
2	PCRXDA	Out
3	PCTXDA	In
4	No Connect	
5	GND	N/A
6	No Connect	
7	No Connect	
8	No Connect	
9	No Connect	

### 2.3.9 J11, CANB 5 x 2 Header

The CANB signals are routed through the SN65HVD235 CAN driver to a 5 x 2 double row header, J11. The pin numbers for J11 and their corresponding signals are shown in the table below.

**Table 12: J11, 5 x 2 Pinout**

Pin #	Signal Name	Pin #	Signal Name
1	No Connect	2	No Connect
3	CANLB	4	CANHB
5	GND	6	No Connect
7	No Connect	8	No Connect
9	No Connect	10	No Connect

The location of the pins are shown in the figure below.

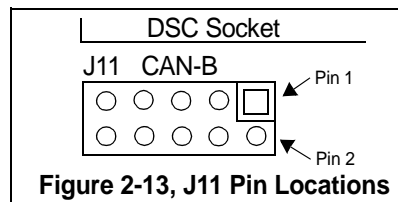

**2.3.10 J12, SCIB 5 x 2 Header**

The SCIB signals are routed through the MAX3238 line driver to a 5 x 2 double row header, J10. The pin numbers for J12 and their corresponding signals are shown in the table below.

**Table 13: J12, 5 x 2 Pinout**

Pin #	Signal Name	Direction	Pin #	Signal Name	Direction
1	No Connect		2	No Connect	
3	PCRxDB	Out	4	No Connect	
5	PCTXDB	In	6	No Connect	
7	No Connect		8	No Connect	
9	GND	N/A	10	No Connect	

The location of the pins are shown in the figure below.

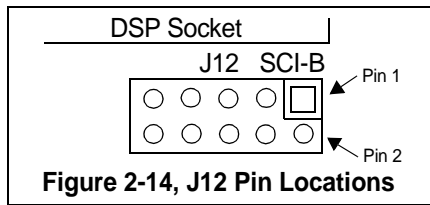

**2.3.11 J201, Embedded USB JTAG Interface**

The USB connector J201 is used to connect to the host development system which is running the software development suite. The signals on this connector are shown in the table below.

**Table 14: J201, Embedded USB JTAG Interface**

Pin #	Signal Name
1	USBVDD
2	D-
3	D+
4	NC
5	USBVSS



### 2.3.12 Connector Part Numbers

The table below shows the part numbers for connectors which can be used on the eZdsp™ F28335. Part numbers from other manufacturers may also be used.

**Table 15: eZdsp™ F28335 Suggested Connector Part Numbers**

Connector	Male Part Numbers	Female Part Numbers
P1	SAMTEC TSW-1-10-07-G-T	SAMTEC SSW-1-10-01-G-T
P2	SAMTEC TSW-1-20-07-G-T	SAMTEC SSW-1-20-01-G-T

\*SSW or SSQ Series can be used

### 2.4 eZdsp™ F28335 Jumpers

The eZdsp™ F28335 has 7 jumpers available to the user which determine how features on the eZdsp™ F28335 are utilized. The table below lists the jumpers and their function. The following sections describe the use of each jumper.

**Table 16: eZdsp™ F28335 Jumpers**

Jumper #	Size	Function	Position As Shipped From Factory
JP1	1 x 2	U29, Pin 2 to ADCREFIN	Installed
JR2	1 x 3	+3.3/5V to XTPD	+3.3 volts
JR4	1 x 3	+5/3.3V to P4, P8	Not populated
JR5	1 x 3	+5/3.3V to P2, P10	Not populated
JR6	1 x 3	MUX GPIO22_24 Select	GPIO24
JP7	1 x 2	CANA Terminator Resistor	Installed
JP8	1 x 2	CANB Terminator Resistor	Installed

**2.4.1 JP1, ADCREFIN Select**

Jumper JP1 is used to connect the output of U29, REF3020 to ADCREFIN. When the jumper is shorted the +2.048 voltage level is routed to the ADCREFIN signal of the DSC. When the jumper is open the ADCREFIN floats. The positions are shown in the table below.

**Table 17: JP1, U29, Pin 2 to ADCREFIN Select**

Position	Function
Shorted *	Output of U29 (+2.048V) connected to ADCREFIN
Open	Use internal reference for ADCREFIN

\* as shipped from factory

The layout of this jumper is shown in the figure below.

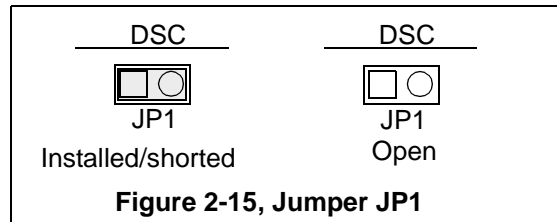

**2.4.2 JR2, XTPD Voltage Select**

Jumper JR2 is a surface mount jumper located on the bottom side of the board. To use a configuration a zero ohm resistor should be used for shorting. This jumper is used to select either +3.3 or +5 volts to be routed to the XTPD pin on the external JTAG header P1, pin 5. In configuration A, +5 volts is routed to XTPD. When configuration B is selected +3.3 volts is routed to XTPD. This is shown below.

**Table 18: JR2, XTPD Voltage Select**

Configuration	Function
A *	+5 volts routed to XTPD
B	+3.3 volts routed to XTPD

\* default

The layout of this jumper is shown in the figure below.

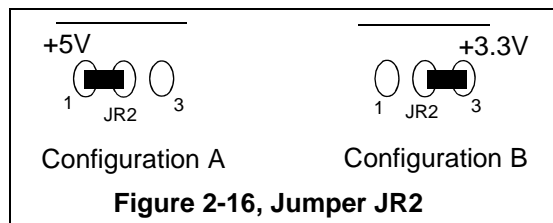

### 2.4.3 JR4, Connector P4, P8 Voltage Select

Jumper JR4 is a surface mount jumper located on the bottom side of the board. To use a configuration a zero ohm resistor should be used for shorting. This jumper allows the user to bring +5 or +3.3 volts to connector P4, pin1, and connector P8, pins 1 and 2. When configuration A is used +5 volts is brought to the connectors. Configuration B routes +3.3 volts to these connectors. These settings are shown below.

**Table 19: JR4, Connector P4, P8 Voltage Select**

Configuration	Function
A	+5 volts routed to P2, pins 1, P8, pins 1,2
B	+3.3 volts routed to P2, pins 1, P8, pins 1,2

The layout of this jumper is shown in the figure below.

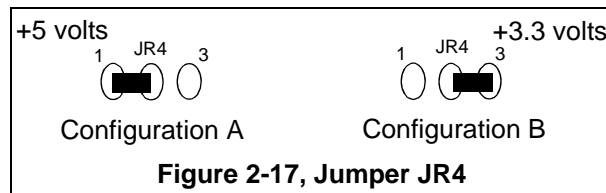

### 2.4.4 JR5, Connector P2, P10 Voltage Select

Jumper JR5 is a surface mount jumper located on the bottom side of the board. To use a configuration a zero ohm resistor should be used for shorting. This jumper allows the user to bring +5 or +3.3 volts to connector P2, pin1 and 2, and connector P10, pins 1 and 2. When configuration A is used +5 volts is brought to the connectors. Configuration B routes +3.3 volts to these connectors. These settings are shown below.

**Table 20: JR5, Connector P2, P10 Voltage Select**

Configuration	Function
A	+5 volts routed to P2, pins 1,2, P10, pins 1,2
B	+3.3 volts routed to P2, pins 1,2, P10, pins 1,2

The layout of this jumper is shown in the figure below.

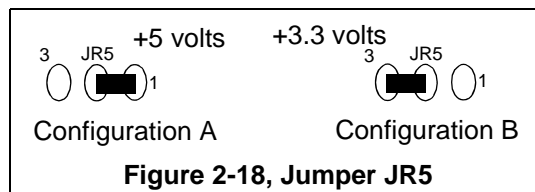

**2.4.5 JR6, MUX GPIO22\_24 Select**

Jumper JR6 is a surface mount jumper located on the bottom side of the board. To use a configuration a zero ohm resistor should be used for shorting. This jumper is used to route the signal GPIO22 or GPIO24 to connector P8, pin 33 (MUX GPIO22). In configuration A GPIO22 is selected. When configuration B is used GPIO24 is selected. These configurations are shown below.

**Table 21: JR6, MUX GPIO22 Select**

Configuration	Function
A	GPIO22 routed to MUX GPIO22_24
B *	GPIO24 routed to MUX GPIO22_24

\* as shipped from factory

The layout of this jumper is shown in the figure below.

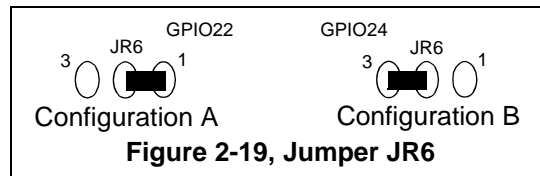

**2.4.6 JP7, CANA Termination Resistor Select**

Jumper JP7 is used to select the termination resistor on the CANA interface. When installed a termination resistor is placed between pins 2 and 7 of the connector P7. This jumper is installed at the factory. The positions are shown in the table below.

**Table 22: JP7, CANA Termination Resistor Select**

Configuration	Function
Installed/shorted	Termination resistor installed
Open	Termination resistor NOT resistor installed

The layout of this jumper is shown in the figure below.

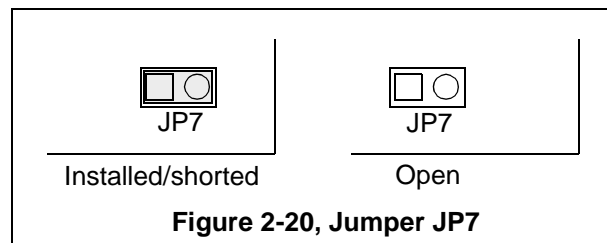

### 2.4.7 JP8, CANB Termination Resistor Select

Jumper JP8 is used to select the termination resistor on the CANB interface. When installed a termination resistor is placed between pins 3 and 4 of the connector J11. This jumper is installed at the factory. The positions are shown in the table below.

**Table 23: JP8, CANB Termination Resistor Select**

Configuration	Function
Installed/shorted	Termination resistor installed
Open	Termination resistor NOT resistor installed

The layout of this jumper is shown in the figure below.

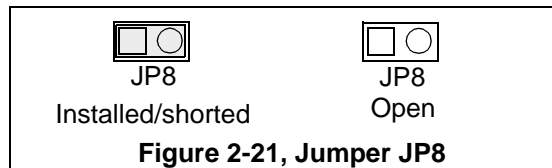

## 2.5 LEDs

The eZdsp™ F28335 has three light-emitting diodes. DS1 indicates the presence of +5 volts and is normally 'on' when power is applied to the board. LED DS2 is under control of the GPIO32 line from the processor. DS201 is connected to the embedded USB emulator and shows the status of the emulation link. These are shown in the table below.

**Table 24: LEDs**

LED #	Color	Controlling Signal
DS1	Green	+5 Volts
DS2	Green	GPIO32
DS201	Green	Embedded emulation link status

**2.6 Switches**

The eZdsp™ F28335 has two switches. SW1 is used to select the power on boot load options. SW2 is used to select the processor configuration.

**2.6.1 SW1, Boot Load Option Switch**

Switch SW1 is used to select the boot load option used by the F28335 processor on power up. These selections are shown in the table below.

**Table 25: SW1, Boot Load Option Switch**

PIN	Position 4 Boot-3 XA15	Position 3 Boot-2 XA14	Position 2 Boot-1 XA13	Position 1 Boot-0 XA12	Boot Mode
1111	OFF	OFF	OFF	OFF	Jump to Flash
1110	OFF	OFF	OFF	ON	SCI-A boot
1101	OFF	OFF	ON	OFF	SPI-A boot *
1100	OFF	OFF	ON	ON	I <sup>2</sup> C-A boot
1011	OFF	ON	OFF	OFF	eCAN-A boot
1010	OFF	ON	OFF	ON	McBSP-A boot
1001	OFF	ON	ON	OFF	Jump to XINTX x16
1000	OFF	ON	ON	ON	Jump to XINTX x32
0111	ON	OFF	OFF	OFF	Jump to OTP
0110	ON	OFF	OFF	ON	Parallel GPIO I/O boot
0101	ON	OFF	ON	OFF	Parallel XINTF boot
0100	ON	OFF	ON	ON	Jump to SARAM
0011	ON	ON	OFF	OFF	Branch to check boot mode
0010	ON	ON	OFF	ON	Branch to Flash, skip ADC CAL
0001	ON	ON	ON	OFF	Branch to SARAM, skip ADC CAL
0000	ON	ON	ON	ON	Branch to SCI, skip ADC CAL

\* As shipped from the factory.

The figure below shows the layout of SW1.

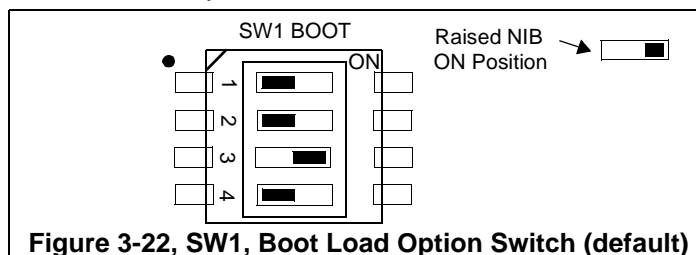

**Figure 3-22, SW1, Boot Load Option Switch (default)**

### 2.6.1 SW2, Processor Configuration Switch

Switch SW2 is used to select the processor configuration. The eZdsp™ F28335 supports 2 on board SCI ports and 2 on board CAN ports. These ports can be used on board or routed to expansion connectors. Switch SW2 controls this configuration. These selections are shown in the table below.

**Table 26: SW2, Processor Configuration Switch**

Position	State	Value	Function
1	OFF *	1	Select GPIO28, GPIO29, GPIO30, GPIO31 as expansion
1	ON *	0	Select GPIO28, GPIO29, GPIO30, GPIO31 as on board SCI/CAN A
2	OFF	1	Disable MUX U22
2	ON *	0	Enable MUX U22
3	OFF	1	Select GPIO8, GPIO9, GPIO10, GPIO11 as expansion
3	ON *	0	Select GPIO8, GPIO9, GPIO10, GPIO11 as on board SCI/CAN B
4	OFF	1	Disable MUX U23
4	ON *	0	Enable MUX U23
5	OFF	1	Write protect I <sup>2</sup> C EEPROM
5	ON *	0	Enable Writes to I <sup>2</sup> C EEPROM
6	OFF	1	I <sup>2</sup> C EEPROM lowest address is 1
6	ON *	0	I <sup>2</sup> C EEPROM lowest address is 0

\* default

The figure below shows the layout of SW2.

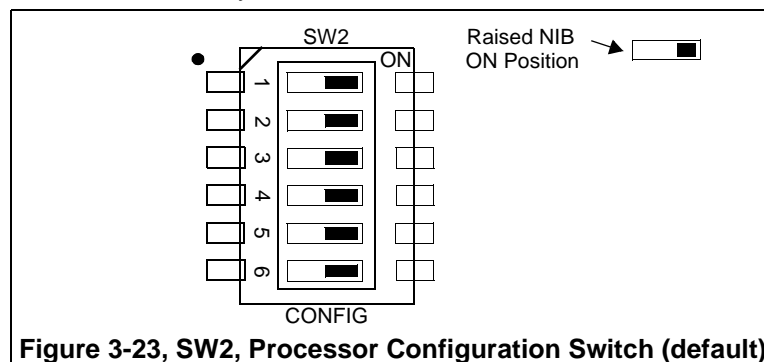

**Figure 3-23, SW2, Processor Configuration Switch (default)**

### 2.7 Test Points

The eZdsp™ F28335 has fifteen test points. Their location on the bottom of the board are shown in the figure below.

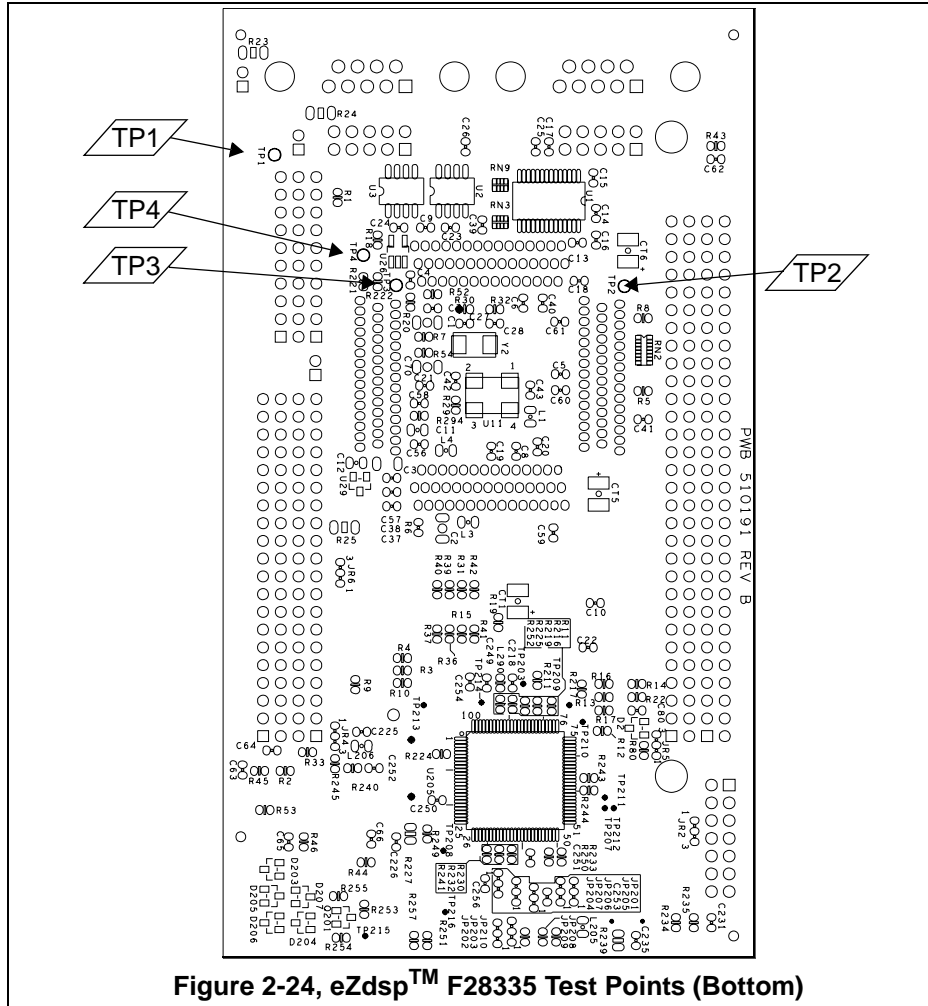

Figure 2-24, eZdsp™ F28335 Test Points (Bottom)



The signals each test point is tied to is listed in the table below.

**Table 27: Test Points**

<b>Test Point</b>	<b>Signal</b>
TP1	AGND
TP2	XCLKOUT
TP3	U8(DSP) Pin 81, TEST1
TP4	U8(DSP) Pin 82, TEST2



# Appendix A

## eZdsp™ F28335

### Schematics

---

---

---

The schematics for the eZdsp™ F28335 can be found on the CD-ROM that accompanies this board. The schematics were drawn on ORCAD.

The schematics are correct for both the socketed and unsocketed version of the eZdsp™.

#### **WARNING !**

The TMS320F28335 supports +3.3V Input/Output levels which are NOT +5V tolerant. Connecting the eZdsp to a system with +5V Input/Output levels will damage the TMS320F28335. If the eZdsp is connected to another target then the eZdsp must be powered up first and powered down last to prevent latchup conditions.

#### **Design Notes:**

1. The TMS320F28335 X1/CLKIN pin is +1.8 volt input. The clock input is buffered with a SN74LVC1G14 whose supply is +1.8 volts. This provides +3.3 volts to the +1.8 volt clock translation. Refer to sheet 4 of the schematics.



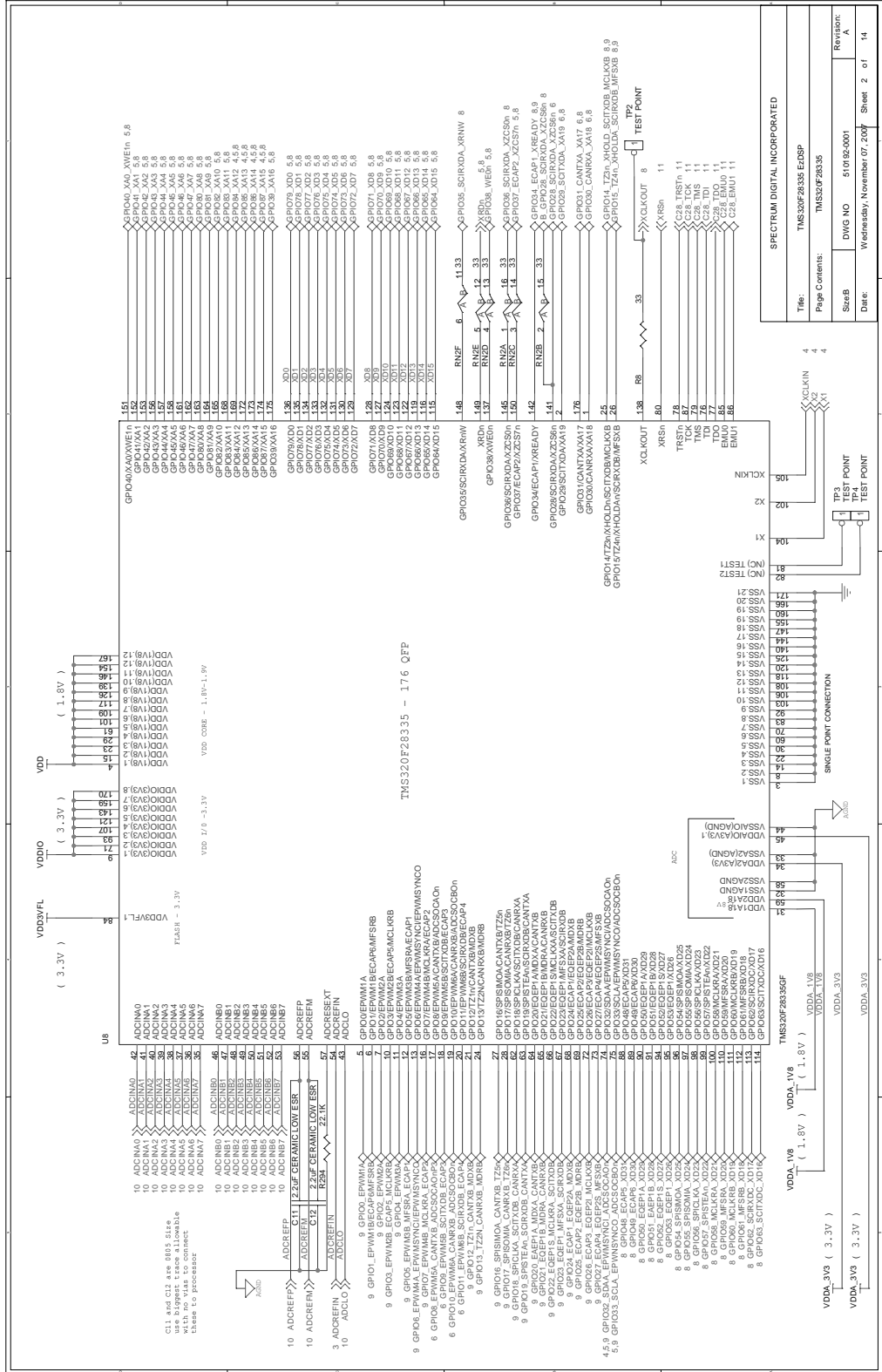

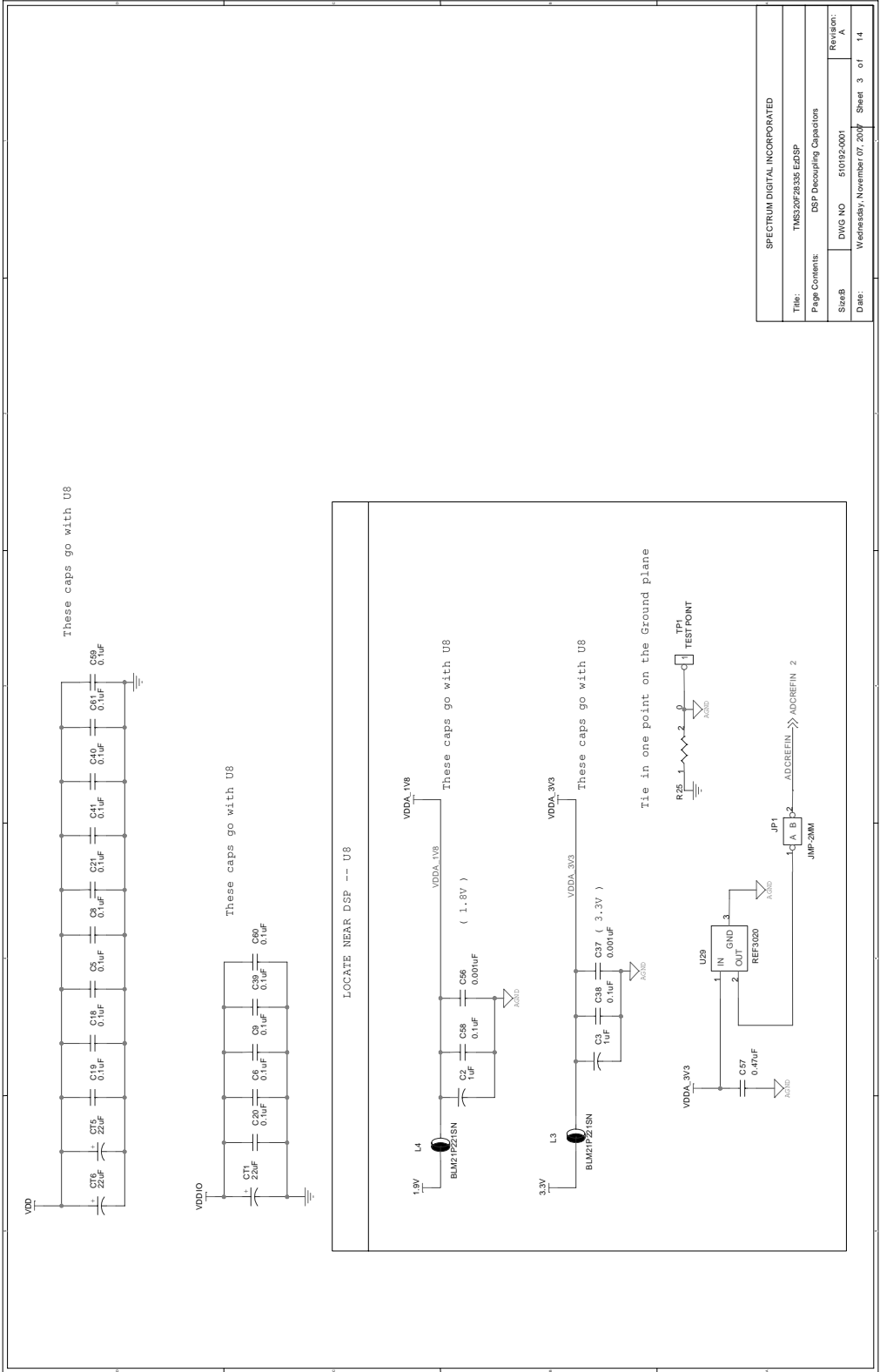

SPECTRUM DIGITAL INCORPORATED			
Title:	TMS320F28335 E2DSP		
Page Content:	DSP Decoupling Capacitors		
Sheet:	DWG NO 51092-0001	Revision:	A
Date:	Wednesday, November 07, 2007	Sheet	3 of 14

Pin	BOOT-3 X15	BOOT-2 X14	BOOT-1 X13	BOOT-0 X12	MODE
0000	ON	ON	ON	ON	Branch to SCI, skip ADC CAL
0001	ON	ON	ON	OFF	Branch to SARAM, skip ADC CAL
0010	ON	ON	OFF	ON	Branch to Flash, skip ADC CAL
0011	ON	ON	OFF	OFF	Branch to check boot mode
0100	ON	OFF	ON	ON	Jump to SARAM
0101	ON	OFF	ON	OFF	Parallel XINTF boot
0110	ON	OFF	OFF	ON	Parallel GPIO I/O boot
0111	ON	OFF	OFF	OFF	Jump to OTP
1000	OFF	ON	ON	ON	Jump to XINTF x32
1001	OFF	ON	ON	OFF	Jump to XINTF x16
1010	OFF	ON	OFF	ON	MCBSF-A boot
1011	OFF	ON	OFF	OFF	eCAN-A boot
1100	OFF	OFF	ON	ON	I2C-A boot
1101	OFF	OFF	ON	OFF	SPI-A boot
1110	OFF	OFF	OFF	ON	SCI-A boot
1111	OFF	OFF	OFF	OFF	Jump to Flash

SPECIMEN DIGITAL INCORPORATED	
Title:	TMS320F28335 EDSBP
Page Contents:	Boot Switches/ OSC
Sheet B	DWG NO 510192-0001
Date:	Wednesday, November 07, 2007
Revision:	A
Sheet 4	of 14

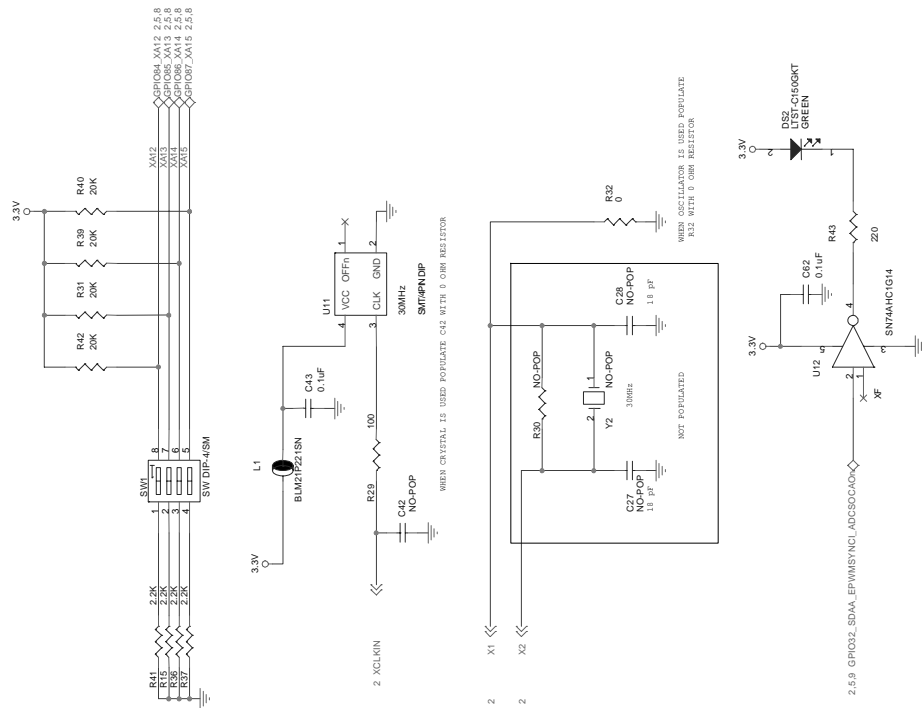

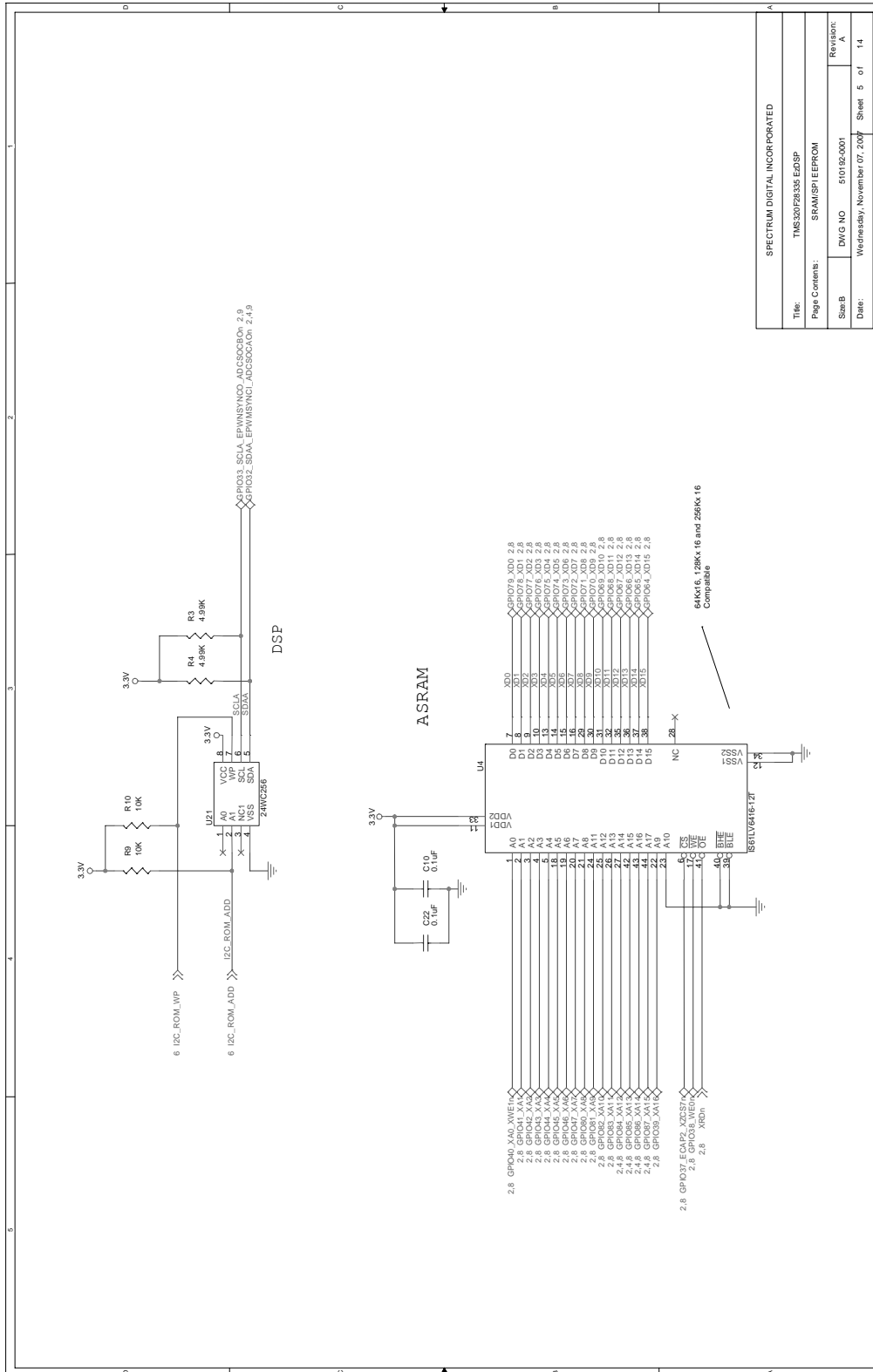

SPECTRUM DIGITAL INCORPORATED	
Title:	TMS320F28335 E2DSP
Page Contents:	SRAM/SPI EEPROM
Size:	DWG NO 510192-0001
Date:	Wednesday, November 07, 2007
Sheet	5 of 14



Switch	Position	Value	Function
SM2-1	OFF	1	Select GPIO28, GPIO29, GPIO30, GPIO31 as expansion
SM2-1	ON	0	Select GPIO28, GPIO29, GPIO30, GPIO31 as on board SCI/CAN A
SM2-2	OFF	1	Disable Mux U22
SM2-2	ON	0	Enable Mux U22
SM2-3	OFF	1	Select GPIO8, GPIO9, GPIO10, GPIO11 as expansion
SM2-3	ON	0	Select GPIO8, GPIO9, GPIO10, GPIO11 as on board SCI/CAN B
SM2-4	OFF	1	Disable Mux U23
SM2-4	ON	0	Enable Mux U23
SM2-5	OFF	1	Write Protect I2C EEPROM
SM2-5	ON	0	Enable Writes to I2C EEPROM
SM2-6	OFF	1	I2C EEPROM lowest address is 1
SM2-6	ON	0	I2C EEPROM lowest address is 0

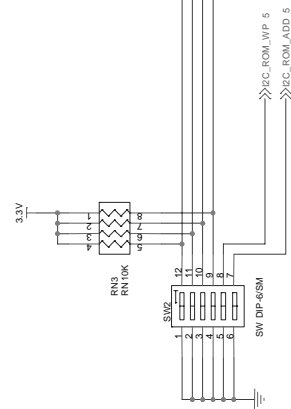
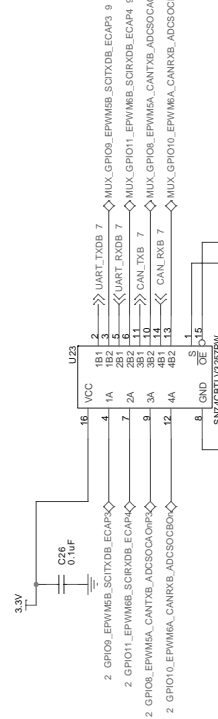
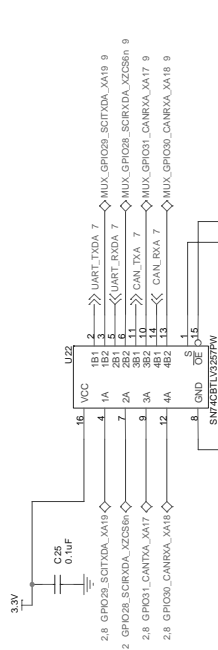

SPECTRUM DIGITAL INCORPORATED			
Title:	TMS320F28335 EZDSP		
Page Contents:	IO MULTIPLEXING		
Size B:	DWG NO	510199-0001	Revision: A
Date:	Wednesday, November 07, 2007	Sheet	6 of 14

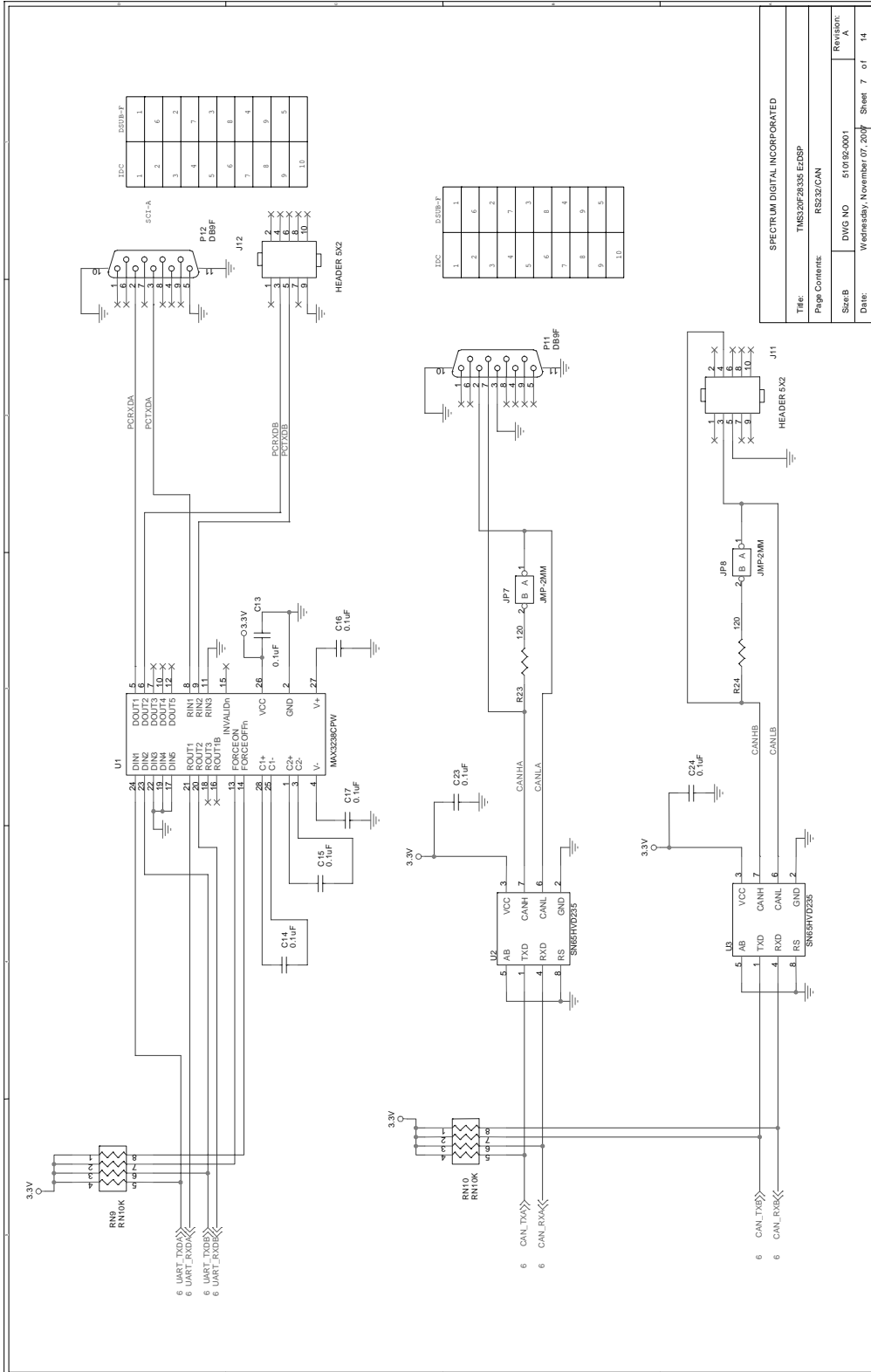

Title:	TMS320F28335 E2DSP
Page Comment:	RS32/CAN
Sheet B	DWG NO 510192001
Date:	Wednesday, November 07, 2007
Sheet 7	of 14





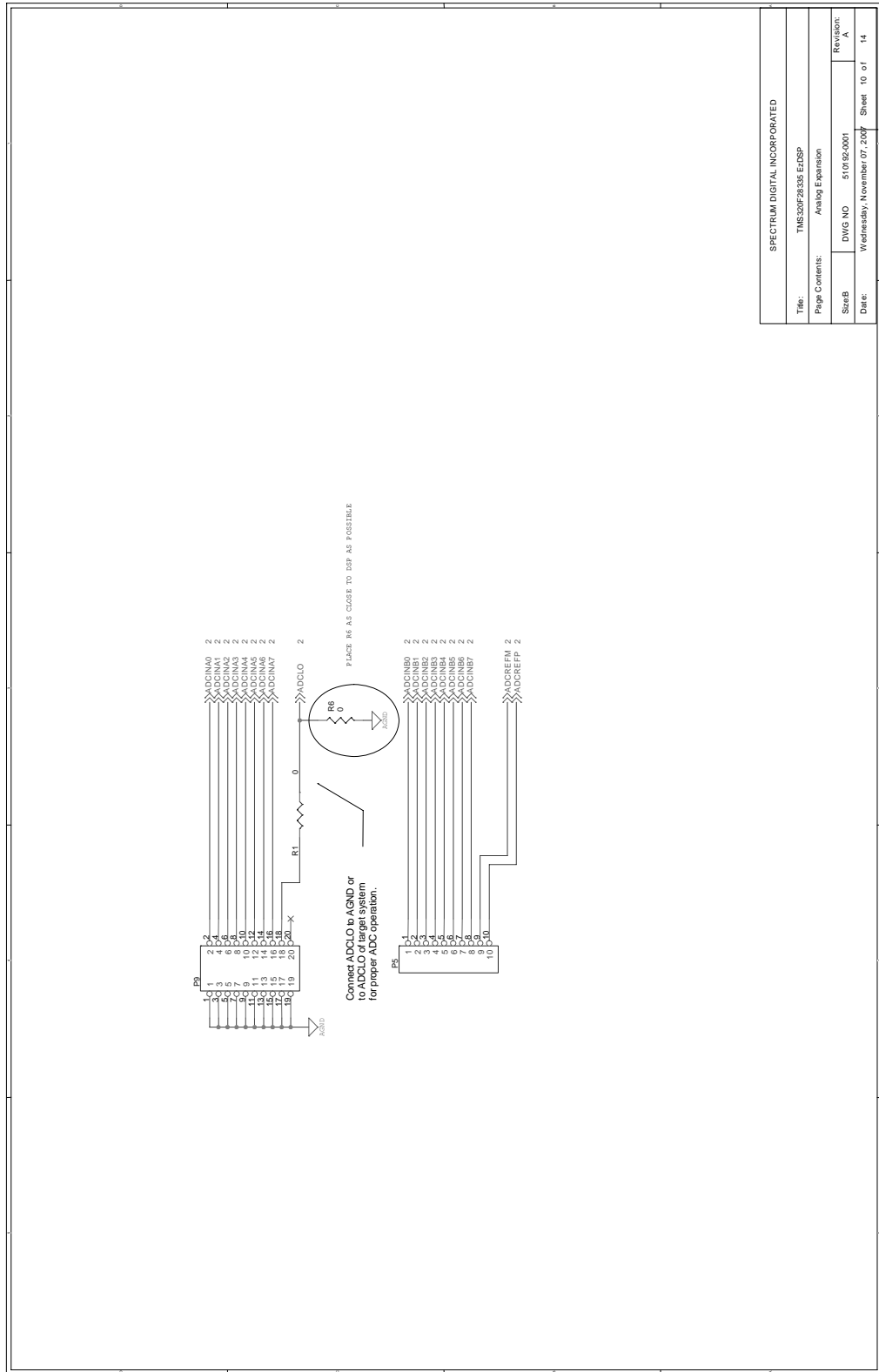

SPECTRUM DIGITAL INCORPORATED			
Title:	TMS320F28355 E28P		
Page Contents:	Analog Expansion		
Size B	DWG NO	51932-001	Revision: A
Date:	Wednesday, November 07, 2007		Sheet 10 of 14





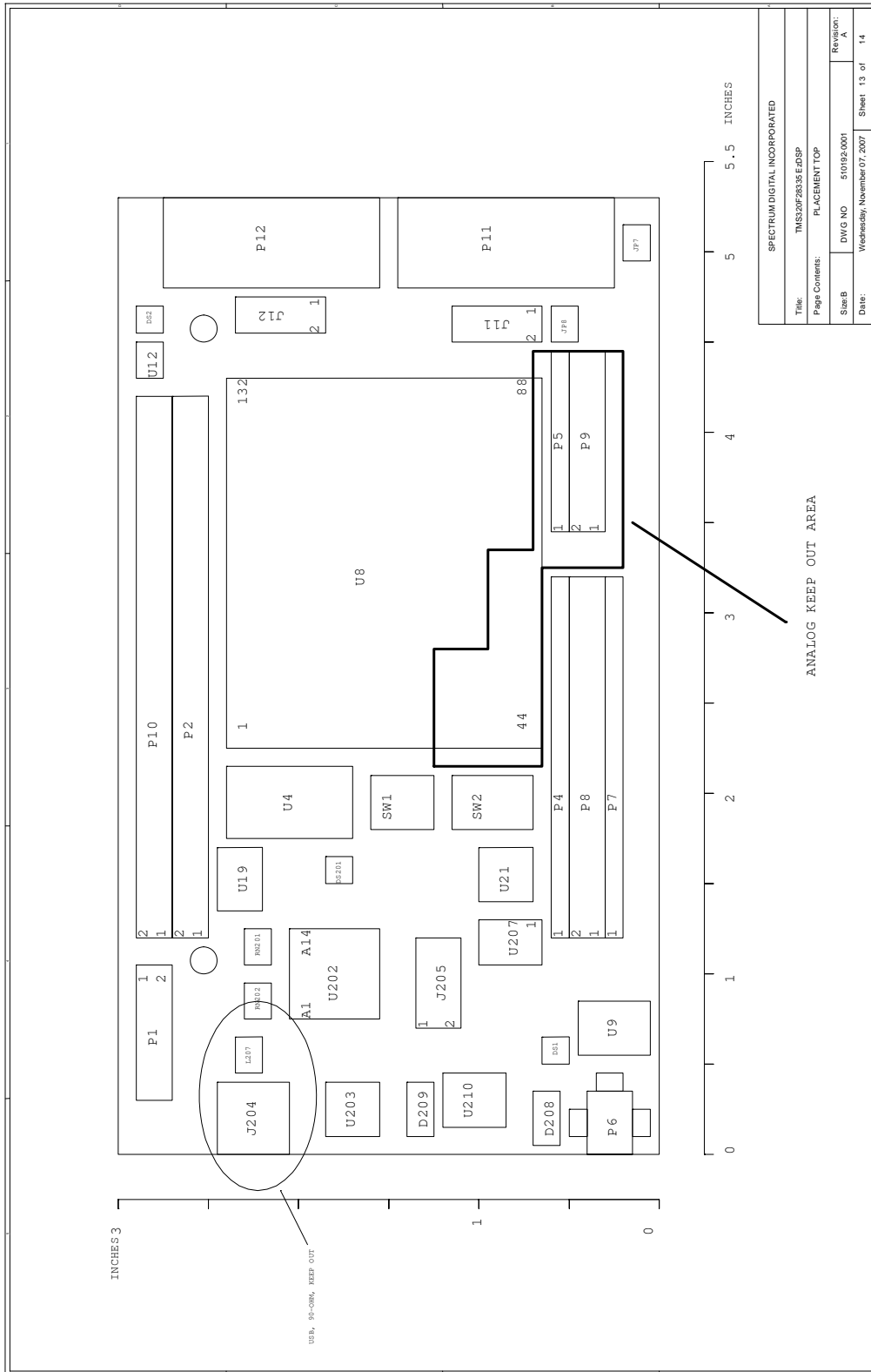



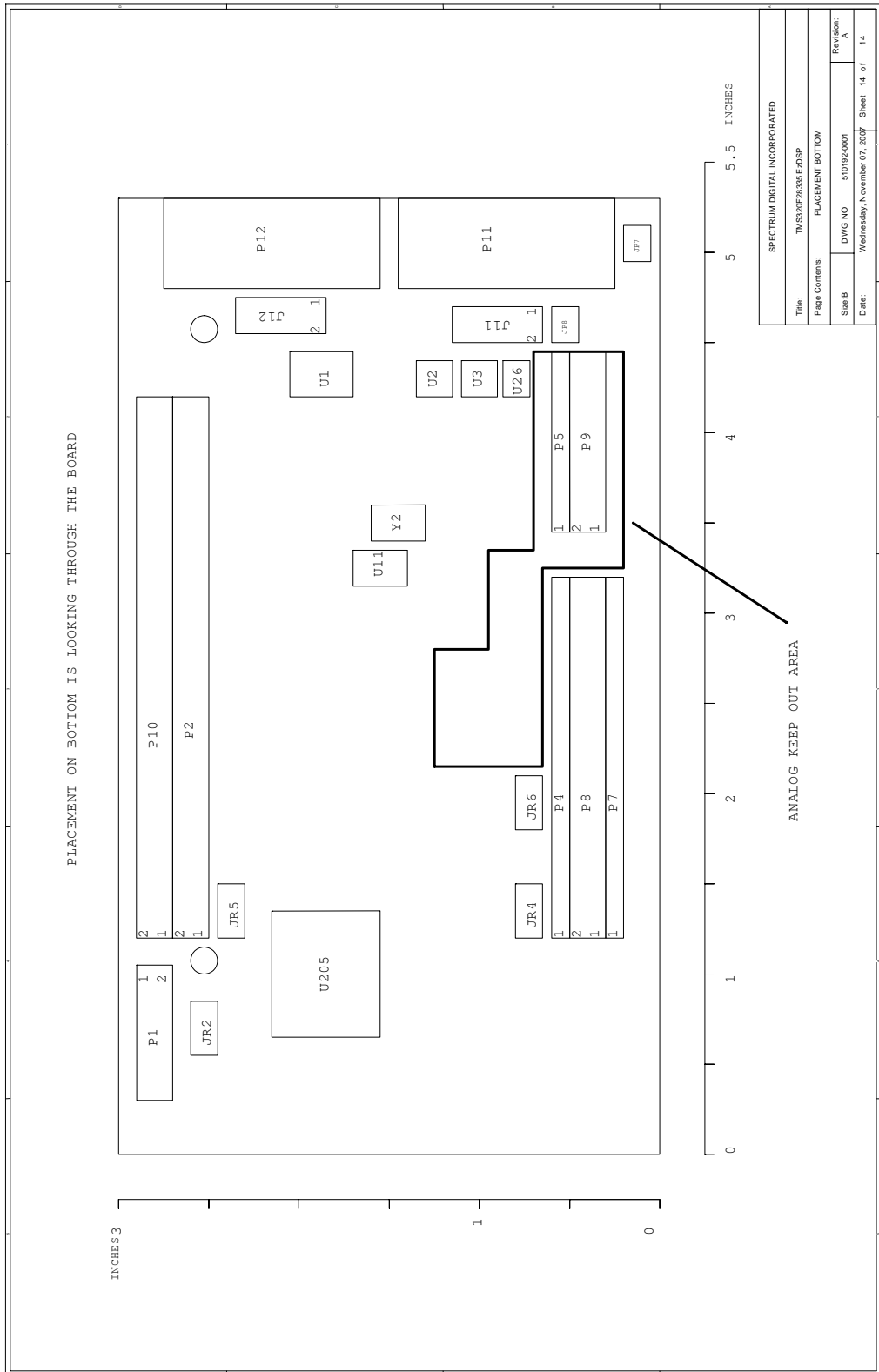



# Appendix B

## eZdsp™ F28335

### Mechanical Information

---

---

---

This appendix contains the mechanical information about the socketed and unsocketed versions of the eZdsp™ F28335

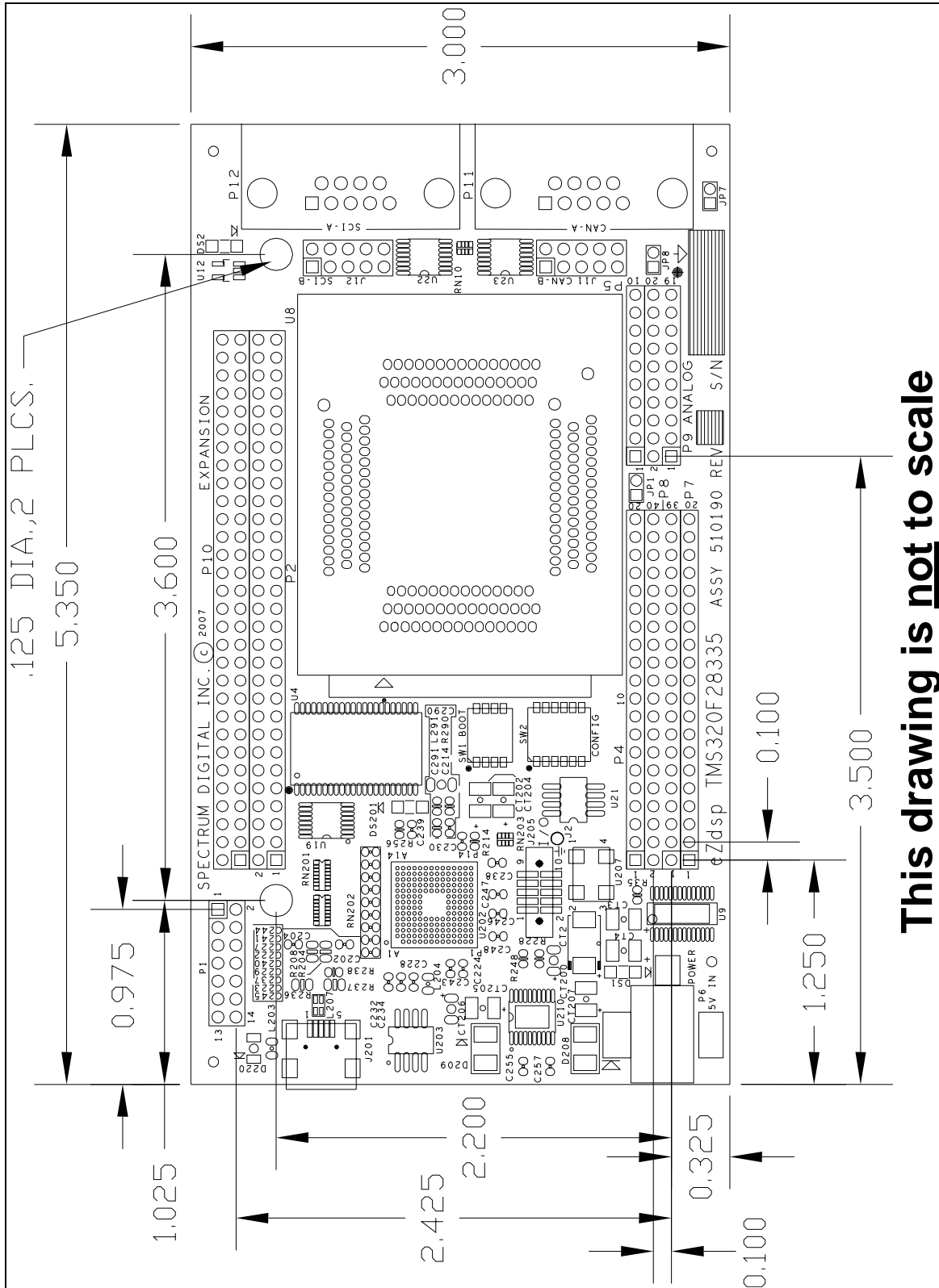

**This drawing is not to scale**







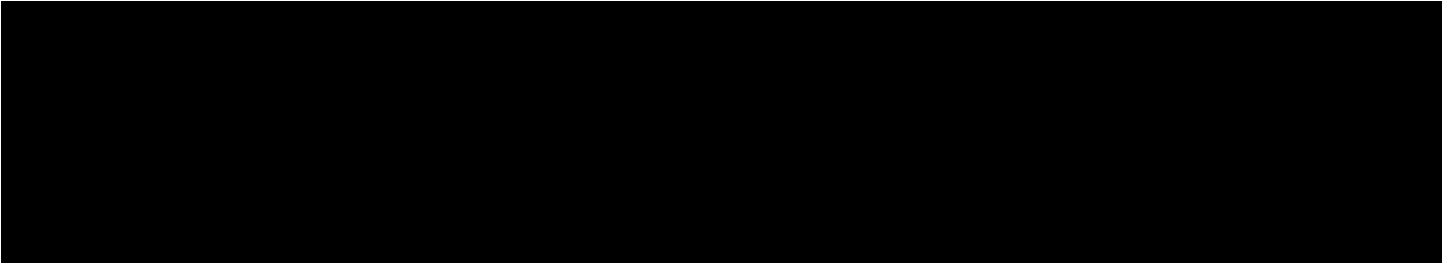

**SPECTRUM**  
*DIGITAL*  
INCORPORATED

Printed in U.S.A., November 2007  
510195-0001 Rev. C

