

Tous droits strictement reserves. Reproduction ou communication a des tiers interdite sous quelque forme que ce soit sans autorisation écrite du propriétaire. Propriete de c FCI. Droits de reproduction FCI.

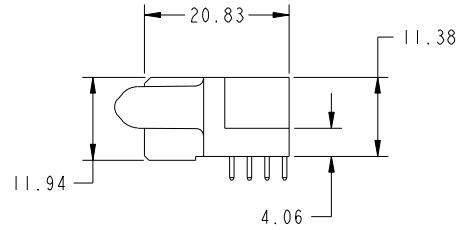

All rights strictly reserved. Reproduction or issue to third parties in any form whatever is not permitted without written authority from the proprietor. Property of FCI. Copyright FCI.

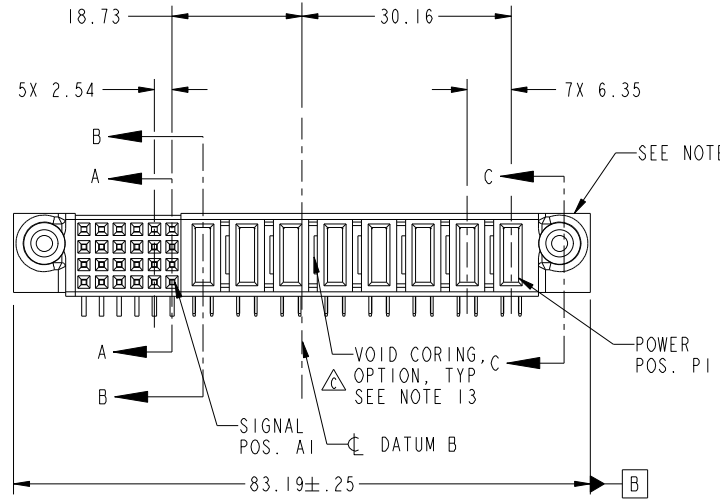
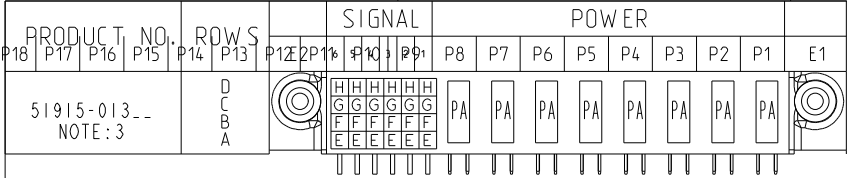

| CODE | DIM "M" MATING LENGTH | CONTACT TYPE |
|------|-----------------------|--------------|
| E | [N/A] | SIGNAL |
| F | [N/A] | SIGNAL |
| G | [N/A] | SIGNAL |
| H | [N/A] | SIGNAL |
| PA | [1.07] | POWER |

| mat'l code | | | | SEE NOTE | | tolerances unless otherwise specified | | CUSTOMER | | |
|-------------|----------------|-----|----------|----------|---------------------|---------------------------------------|-----------------------------------|-----------|--|-------|
| ltr | ecn no. | dr | date | linear | 0.X ± 0.5 | projection | COPY | | | |
| A | V21246 | CGD | 07/31/02 | | 0.XX ± 0.25 | | title | | | |
| B | DG05-0355 | CS | 09/26/05 | angles | 0.XXX ± 0.10 | | 8P + 24S R/A SOLDER RECEPTACLE | | | |
| C | DG07-0498 | JW | 09/15/08 | | 0° ± 2° | | product family PwrBlade code | | | |
| | | | | dr | C. DAILY 07/31/02 | | size | dwg no | | 213 |
| | | | | enr | J. ALLISON 07/31/02 | | | 51915-013 | | sheet |
| | | | | chr | J. ALLISON 07/31/02 | | | 1 of 4 | | |
| | | | | appd | J. ALLISON 07/31/02 | | | cage code | | |
| sheet index | revision sheet | C 1 | C 2 | C 3 | C 4 | 22526 | | 4 | | |

Pro/E

cage code 22526

Tous droits strictement reserves. Reproduction ou communication a des tiers interdite sous quelque forme que ce soit sans autorisation écrite du propriétaire. Propriete de c FCI. Droits de reproduction FCI.



All rights strictly reserved. Reproduction or issue to third parties in any form whatever is not permitted without written authority from the proprietor. Property of FCI. Copyright FCI.

PRODUCT NUMBER
51915-013--
NOTE: 3

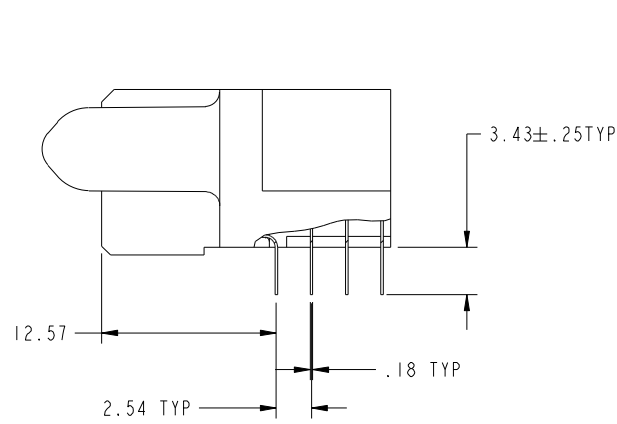

BROKEN-OUT SECTION A-A
SCALE 2:1

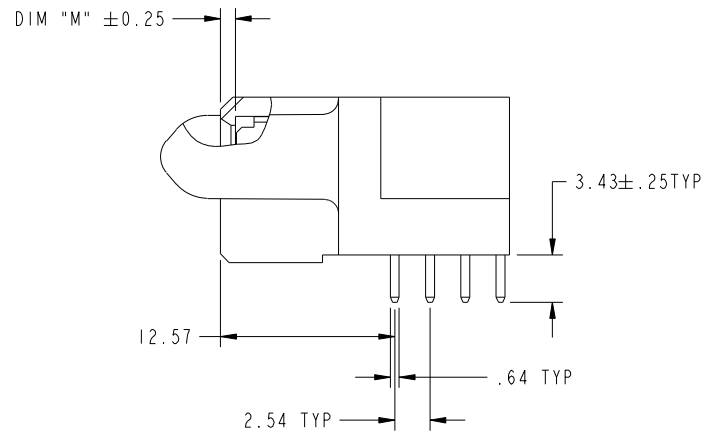

BROKEN-OUT SECTION B-B
SCALE 2:1

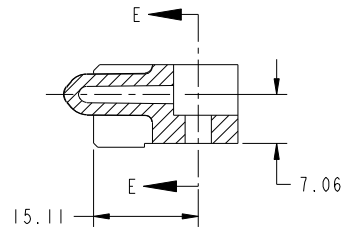

SECTION C-C

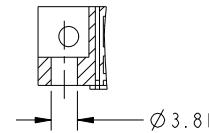

PARTIAL SECTION E-E

| | | | | | | | | | |
|-------------|----------------|----------|------|---------------------------------------|---------------------|------------|--|-----------------------------------|--|
| mat'l code | | SEE NOTE | | tolerances unless otherwise specified | | CUSTOMER | | www.fciconnect.com | |
| ltr | ecn no. | dr | date | linear | 0.X ± 0.5 | COPY | | title | |
| C | | | | | 0.XX ± 0.25 | projection | | 8P + 24S R/A SOLDER RECEPTACLE | |
| | | | | angles | 0.XXX ± 0.10 | | | product family PwrBlade code | |
| | | | | dr | 0° ± 2° | | | size | |
| | | | | enr | C. DAILY 07/31/02 | scale | | 213 | |
| | | | | chr | J. ALLISON 07/31/02 | 1:1 | | sheet | |
| | | | | appd | J. ALLISON 07/31/02 | A | | 2 | |
| sheet index | revision sheet | | | | | | | cage code | |
| | | | | | | | | 22526 | |

Pro/E

cage code 22526

Tous droits strictement reserves. Reproduction ou communication a des tiers interdite sous quelque forme que ce soit sans autorisation écrite du propriétaire. Propriete de c FCI. Droits de reproduction FCI.



All rights strictly reserved. Reproduction or issue to third parties in any form whatever is not permitted without written authority from the proprietor. Property of FCI. Copyright FCI.

PRODUCT NUMBER
51915-013--
NOTE: 3

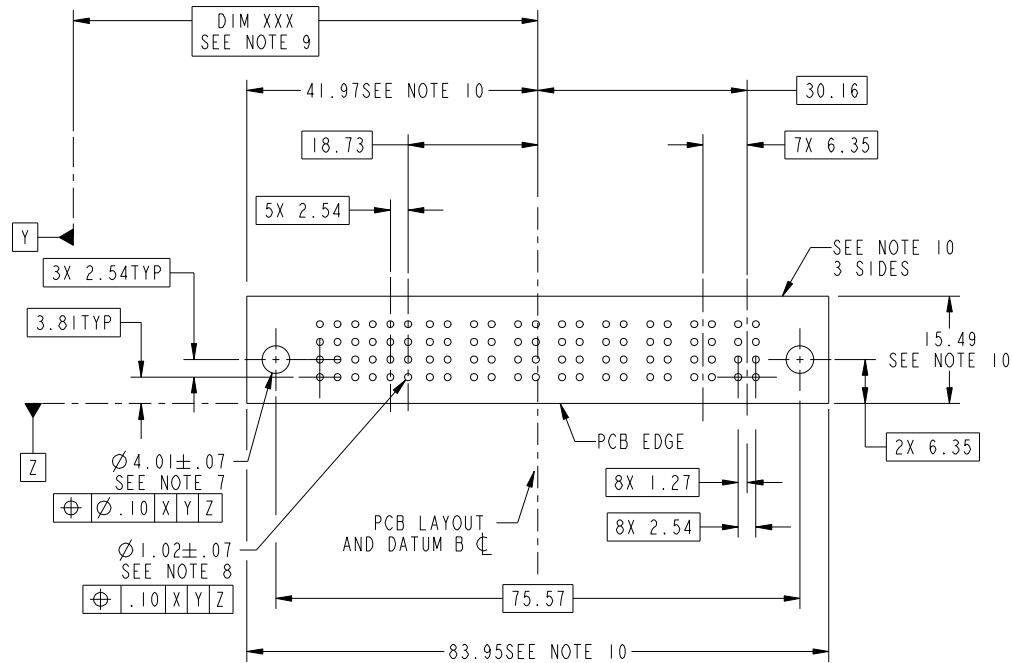

| | | | | | | | | | |
|-------------|----------------|----------|------|---------------------------------------|---------------------|------------|--|-----------------------------------|--|
| mat'l code | | SEE NOTE | | tolerances unless otherwise specified | | CUSTOMER | | www.fciconnect.com | |
| ltr | ecn no. | dr | date | linear | 0.X ± 0.5 | COPY | | title | |
| C | | | | | 0.XX ± 0.25 | projection | | 8P + 24S R/A SOLDER RECEPTACLE | |
| | | | | angles | 0.XXX ± 0.10 | | | product family PwrBlade code | |
| | | | | dr | 0° + 2° | | | size 213 | |
| | | | | enr | C. DAILY 07/31/02 | scale | | sheet 3 | |
| | | | | chr | J. ALLISON 07/31/02 | 1:1 | | dwg no 51915-013 | |
| | | | | appd | J. ALLISON 07/31/02 | | | cage code 22526 | |
| sheet index | revision sheet | | | | | | | | |

Pro/E

cage code 22526

Tous droits strictement reserves. Reproduction ou communication a des tiers interdite sous quelque forme que ce soit sans autorisation écrite du propriétaire. Propriete de c FCI. Droits de reproduction FCI.



All rights strictly reserved. Reproduction or issue to third parties in any form whatever is not permitted without written authority from the proprietor. Property of FCI. Copyright FCI.

PRODUCT NUMBER
51915-013--
NOTE: 3

NOTES:

1. DIMENSIONS AND TOLERANCES ARE IN ACCORDANCE WITH ASME Y14.5M, 1994 UNLESS OTHERWISE SPECIFIED.

CONNECTOR NOTES:

2. HOUSING MATERIAL: UL 94 V-0 GLASS FILLED
HIGH-TEMP THERMOPLASTIC
POWER CONTACT MATERIAL: COPPER ALLOY
SIGNAL PIN MATERIAL: COPPER ALLOY

3. PLATING:
SEE ITEM 5 & 6 INPRINT 10064183 FOR PLATING SPEC OF 51915-013; 51915-013LF RESPECTIVELY

4. MANUFACTURER'S NAME, P/N, AND DATE CODE TO APPEAR ON THIS SURFACE.

5. PRODUCT SPECIFICATION GS-12-149.
APPLICATION SPECIFICATION BUS-20-067.

PCB NOTES:

6. ALL HOLE DIAMETERS ARE FINISHED HOLE SIZE.

7. MOUNTING HOLES, WHERE APPLICABLE, ARE UNPLATED.

8. $\varnothing 1.151 \pm 0.025$ DRILLED HOLES PLATED WITH
0.008 MIN SnPb OR Sn OVER 0.03
TO 0.08 Cu PLATING TO ACHIEVE
 $\varnothing 1.02 \pm .07$ HOLE.

9. "DIM XXX" TO BE DETERMINED BY THE CUSTOMER.

10. CONNECTOR KEEP-OUT ZONE.

11. A \triangle SYMBOL WILL BE NEXT TO ANY DIMENSION, VIEW, OR NOTE WHICH HAS BEEN MODIFIED WITH THE CURRENT DRAWING REVISION.

13. THE VOID CORING IN BETWEEN POWER MODULES, SIGNAL MODULES AND END MODULES ARE OPTIONAL AND THE SHAPE MAY BE DIFFERENT FOR OPTIMIZING THE MOLDING PROCESS. THE VOID CORING WILL NOT EFFECT TO PRODUCT FUNCTION.

| | | | | | | | | | | | |
|-------------|---------|----------------|------|----------|---------------------|---------------------------------------|----------------|----------|-----------------------|---------------------------|------|
| mat'l code | | | | SEE NOTE | | tolerances unless otherwise specified | | CUSTOMER | | FCI www.fciconnect.com | |
| ltr | ecn no. | dr | date | linear | 0.X ± 0.5 | projection | COPY | | title | | |
| C | | | | | 0.XX ± 0.25 | | 8P + 24S | | R/A SOLDER RECEPTACLE | | |
| | | | | angles | 0.XXX ± 0.10 | | product family | | PwrBlade | | code |
| | | | | dr | 0 ± 2° | MIM | | size | dwg no | 213 | |
| | | | | enr | C. DAILY 07/31/02 | ← MIM → | | A | 51915-013 | sheet | |
| | | | | chr | J. ALLISON 07/31/02 | scale | | | | 4 | |
| | | | | appd | J. ALLISON 07/31/02 | 1:1 | | | | | |
| sheet index | | revision sheet | | | | | | | | | |

cage code 22526

Pro/E