

Applications

- Distributed Power Architectures
- Telecommunications Equipment
- LAN/WAN
- Data Processing

Features

- Standard 1/2-brick footprint and pinout
- 100V/100ms input voltage surge
- Low Profile (12.7mm)
- Input-to-output isolation: 1500VDC
- Basic insulation
- High efficiency - to 90% at full load
- Start-up into high capacitive load
- Start-up into pre-biased loads
- Back-drive protection
- Remote sense
- Low conducted and radiated EMI
- Output overcurrent protection
- Output overvoltage protection
- Overtemperature protection
- Remote On/Off (primary referenced), positive or negative logic
- Output voltage trim adjust, positive or negative
- UL 1950 Recognized, CSA 22.2 No. 950-95 certification, TUV IEC95

Description

The HHS60 series of high-density, single-output DC/DC converters is ideal for telecom and datacom systems that require low voltage at high current in an industry-standard, half-brick footprint. Highly efficient topology and thermally-optimized construction allow the units to provide high output current in the system over a wide operating temperature range while still maintaining a safe guardband for component electrical and thermal ratings. The addition of an external heatsink increases the capacity of the unit. The HHS60 employs 100% surface-mount components for consistency and reliability in our production process, and is available in four standard output voltages from 1.5 V to 3.3 V.

Model Selection						
Model	Input Voltage VDC	Input Current, Max ¹ ADC	Output Voltage VDC	Output Rated Current I _{rated} ADC	Output Ripple/Noise, mV p-p	Typical Efficiency @ I _{rated} %
HHS60ZE	36-75	6.5	3.3	60	150	90
HHS60ZD	36-75	4.9	2.5	60	150	89
HHS60ZB	36-75	3.6	1.8	60	150	86
HHS60ZA	36-75	3.1	1.5	60	150	85

This product is intended for integration into end-use equipment. All the required procedures for CE marking of end-use equipment should be followed.

¹ specified @ V_{IN} min.

Absolute Maximum Ratings

Stresses in excess of the absolute maximum ratings may cause performance degradation, adversely effect long-term reliability, and cause permanent damage to the converter.

Parameter	Conditions/Description	Min	Max	Units
Input voltage	Continuous		75	VDC
	Transient, 100ms		100	VDC
Operating Temperature	Baseplate	-40	100	°C
Storage Temperature		-55	125	°C
ON/OFF Control Voltage	Referenced to -Vin		50	VDC

Environmental, Mechanical, & Reliability Specifications

All specifications apply over specified input voltage, output load, and temperature range, unless otherwise noted.

Parameter	Conditions/Description	Min	Nom	Max	Units
Operating Temperature	Baseplate	-40		100	°C
Operating Humidity	Relative humidity, non-condensing			95	%
Storage Humidity	Relative humidity, non-condensing			95	%
Shock	½ Sine, 6ms, 3 axes	50			g
Sinusoidal Vibration	GR-63-CORE, Section 5.4.2	1			
Weight			3.3/92		Oz/g
Water Washing	Standard process		Yes		
MTBF (Calculated)	Per Bellcore TR-NWT-000332 (50% stress, 40°C)		1,200		kHrs
Dimensions	(overall)	2.28 (57.9) x 2.4 (61) x 0.5 (12.7)			in (mm)

Isolation Specifications

All specifications apply over specified input voltage, output load and temperature range, unless otherwise noted.

Parameter	Conditions/Description	Min	Nom	Max	Units
Insulation Safety Rating		Basic			
Isolation Voltage	Input/Output	1500			VDC
	Input to Baseplate	1500			VDC
	Output to Baseplate	1500			VDC
Isolation Resistance		10			MΩ
Isolation Capacitance	Input to Output		500		pF

Safety Regulatory Compliance

Safety Agency	Standard Approved To:	Marking
Underwriters Laboratories	UL60950/CSA60950-00	cULus
TUV product Service	TUV EN60950:2000	TUV PS Baurt mark
CB report	IEC60950:1999	N/A.

Input Specifications

All specifications apply over specified input voltage, output load and temperature range, unless otherwise noted.

Parameter	Conditions/Description	Min	Nom	Max	Units
Input Voltage	Continuous	36	48	75	VDC
Turn-On Input Voltage	Ramping Up ¹	33	34	35	VDC
Turn-Off Input Voltage	Ramping Down ¹	31	32	33	VDC
Input Reflected Ripple Current	Full Load, 12 μ H source inductance BW=20MHz ²		2.6	50	mA p-p
Inrush Transient	Vin=Vin.max		0.1	1	A ² s

¹ Refer to Fig. 9 for waveform.

² Refer to Fig. 18 for Test circuit. / measurement method?

Output Specifications

All specifications apply over specified input voltage, output load, and temperature range, unless otherwise noted.

Parameter	Conditions/Description	Min	Nom	Max	Units
Output Voltage Set-point Accuracy:	Vin=48Vdc, Full Load	-1.2		1.2	%Vout
Output Current	I _{rated}	3*		60	ADC
Line Regulation:	(Vin= 36V to 75V)			0.2	%Vout
Load Regulation:	Vin=Vnom, I _{o,min} to I _{o,max}			0.2	%Vout
Output Temperature Regulation	(T _{Baseplate}) = -40°C to +100°C)			0.03	%/°C
Ripple and Noise, DC to 20MHz ^{1,2}	Over line and load Tamb= 0°C to 85°C		75 15	150 40	mV p-p mV _{RMS}
Dynamic Regulation	75-100-75% load step change, to 1% error band di/dt=0.1A/ μ s				
Peak Deviation			6	8	%Vout
Settling Time			200	500	μ s
Peak Deviation	di/dt=1A/ μ s		6	8	%Vout
Settling Time			125	400	μ s
Turn-On Time (turn-on via application of Vin)	Time from Vin=UVLO to regulation band		15	20	ms
Turn-On Time (turn-on via ON/OFF signal)	Time from ON/OFF signal to regulation band		12	15	ms
Rise Time	from 10 to 90% of Vout.nom			10	ms
Turn-on Overshoot	Over all input voltage, load, and temperature conditions		1	5	%Vout
Admissible Load Capacitance	I _{rated} , Nom Vin			15,000	μ F
Backdrive Protection	No damage to converter		Yes		
Switching Frequency			400		kHz

¹ At I_{out}<I_{out,min}, the output may contain low frequency component that exceeds ripple specifications.

² See Figure 12 for test setup

Protection Specifications

All specifications apply over specified input voltage, output load, and temperature range, unless otherwise noted.

Parameter	Conditions/Description	Min	Nom	Max	Units
Overcurrent Protection ¹					
Type	Non-latching – Hiccup mode, auto-recovery				
Threshold		64		78	A _{dc}
Short Circuit				30	A _{RMS}
Overvoltage Protection ²					
Type	Clamping, auto-recovery				
Threshold	V _{in} = V _{in.nom} , I _{out} =I _{rated}	120		140	V _{dc}
Overtemperature Protection					
Type	Non-latching, auto-recovery				
Threshold	Baseplate temperature	105	110	115	°C
Recovery			90		°C

¹ See Fig. 13

² See Fig. 14

Feature Specifications

All specifications apply over specified input voltage, output load and temperature range, unless otherwise noted.

Parameter	Conditions/Description	Min	Nom	Max	Units
ON/OFF					
Negative Logic (-N suffix)	ON/OFF signal is low or the pin is connected to -V _{in} – converter is ON V _{on/off} in reference to -V _{in}				
Converter ON	ON/OFF pin is connected to -V _{in}	-0.5		1.8	VDC
Source Current	V _{on/off} in reference to -V _{in}		0.5	1	mADC
Converter OFF	ON/OFF pin is floating	3.5		20	VDC
Open Circuit Voltage				5	VDC
Positive Logic (no suffix)	On/Off signal is low or the pin is floating –converter is OFF V _{on/off} in reference to -V _{in}				
Converter ON	ON/OFF pin is floating	3.5		10	VDC
Open Circuit Voltage	V _{on/off} in reference to -V _{in}			5	VDC
Converter OFF	ON/OFF pin is connected to -V _{in}	-0.5		1.8	VDC
Source Current			0.5	1	mADC
Remote Sense ¹					
Remote Sense Headroom				10	%V _{out}
Output Voltage Trim ¹					
Trim Up	V _{in} = V _{in.nom} , I _{out} =I _{rated}			10	V _{dc}
Trim Down	V _{in} = V _{in.nom} , I _{out} =I _{rated}			-10	V _{dc}

¹ V_{out} can be increased up to 10% via the sense leads or up to 10% via the trim function, however total output voltage trim from all sources should not exceed 10% of V_{out}.

Efficiency Characteristics

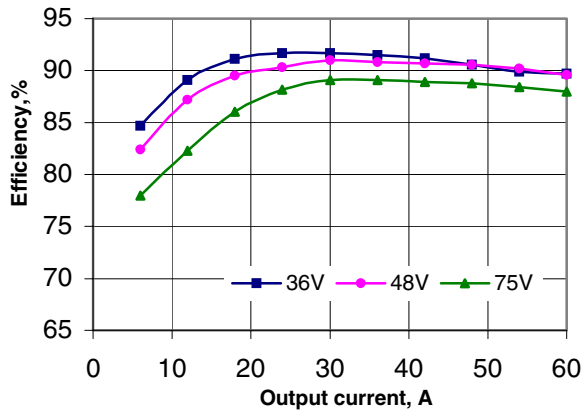

Figure 1. HHS60ZE (3.3V) Efficiency Curves

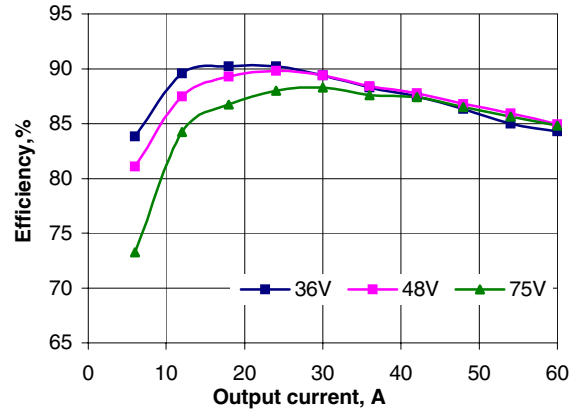

Figure 4. HHS60ZA (1.5V) Efficiency Curves

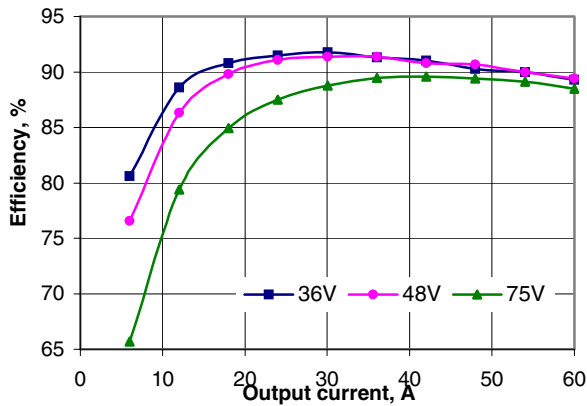

Figure 2. HHS60ZD (2.5V) Efficiency Curves

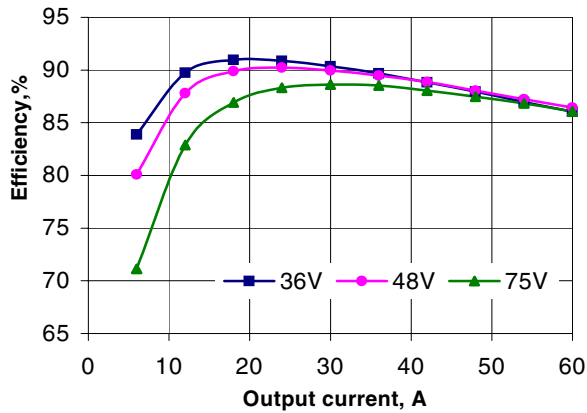

Figure 3. HHS60ZB (1.8V) Efficiency Curves

Power Derating Characteristics

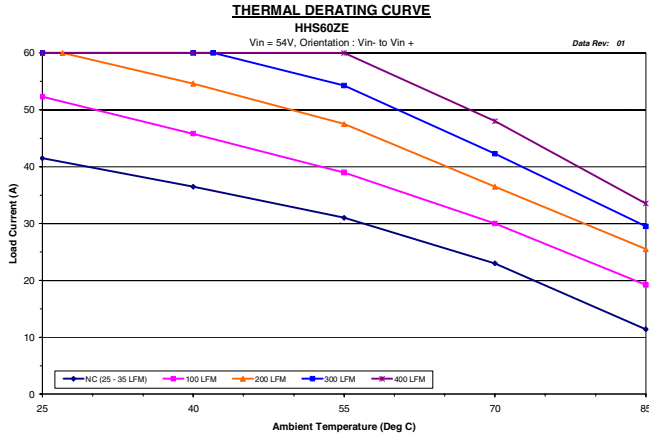

Figure 5. HHS60ZE (3.3V) Derating Curves

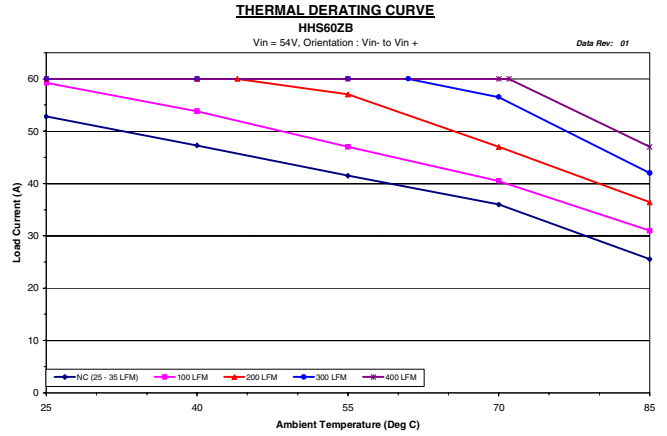

Figure 7. HHS60ZB (1.8V) Derating Curves

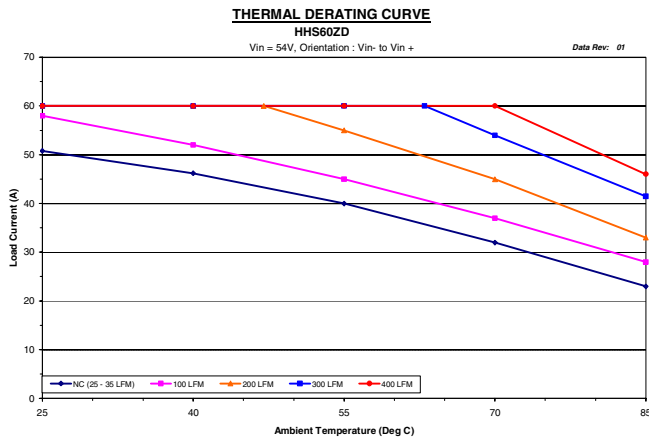

Figure 6. HHS60ZD (2.5V) Derating Curves

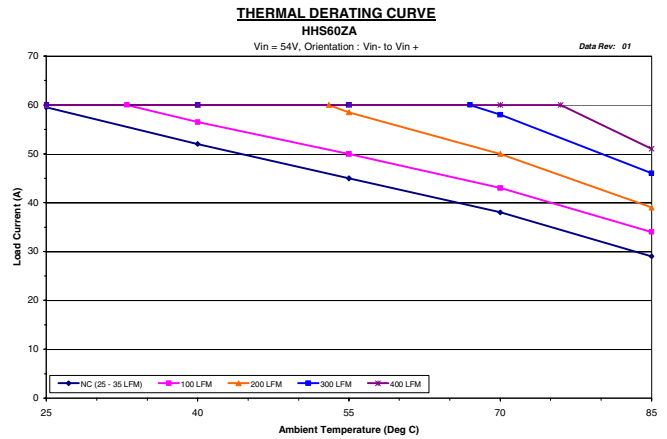

Figure 8. HHS60ZA (1.5V) Derating Curves

UVLO Operation

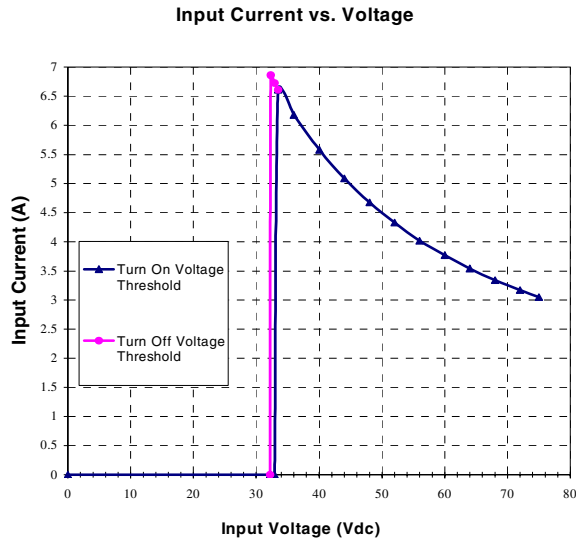

Figure 9. HHS60 Input UVLO Characteristics

Turn-on Characteristics

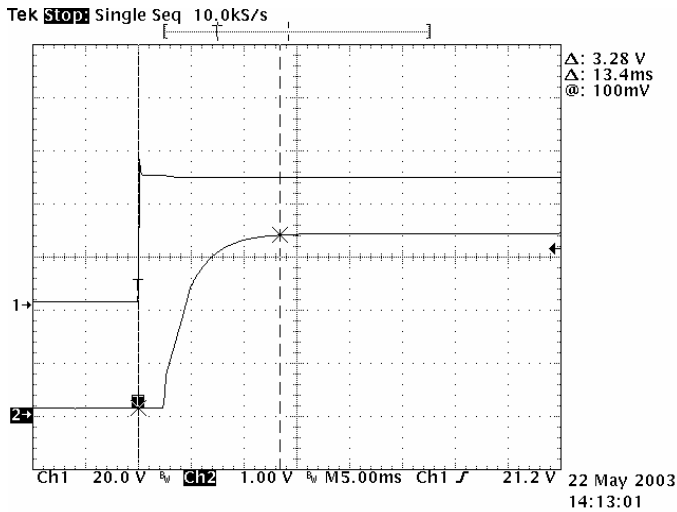

Figure 10. Output Voltage turn-on HHS60ZE
Conditions: Vin=48V, Load: full, , Co=none
(Note: monotonic rise characteristic)

Output Ripple and Noise

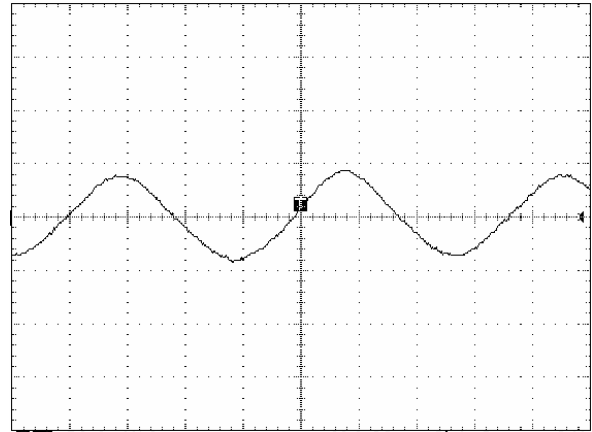

Figure 11. HHS60ZE Output Ripple Characteristics
Vin=48V and Iout=3A

To improve accuracy and repeatability of ripple and noise measurements, Power-One utilizes the test setup shown in Figure 12.

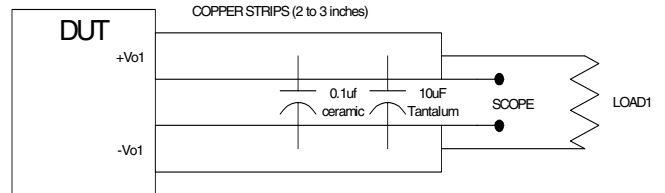

Figure 12 Output ripple and noise measurement test setup

A BNC connector is used for the measurements to eliminate noise pickup associated with long ground leads of conventional scope probes. The connector, a 0.1µF ceramic and a 10µF tantalum capacitors, and the load are located 2-3” away from the converter.

Short Circuit Operation

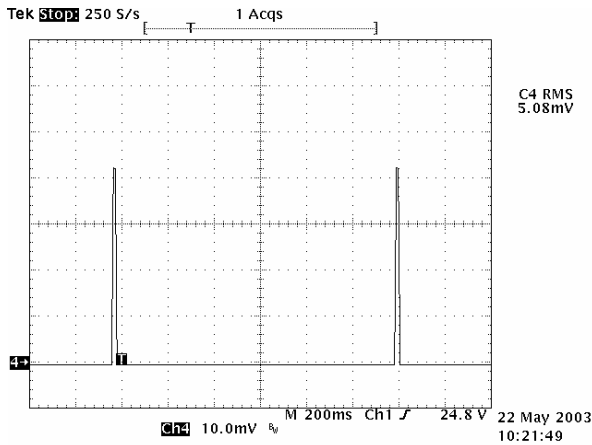

Figure 13 Output current with shorted output pins, $V_{in} = 48V_{dc}$, Scale is 20Amp/Div.

Once the output current is brought back into its specified range, the converter automatically exits the hiccup mode and continues normal operation.

Overvoltage Protection

The output overvoltage protection consists of a separate control loop, independent of the primary control loop. This control loop has a higher voltage set point than the primary loop. In a fault condition the converter limits its output voltage and latches off. Figure 14 shows operation of the converter under an overvoltage condition.

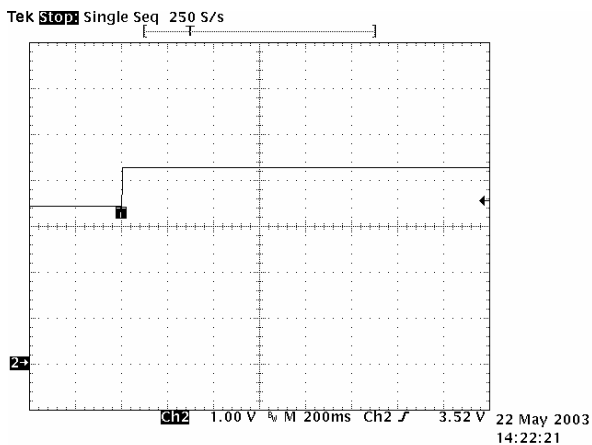

Figure 14 Output Voltage of an HHS60ZE Under a Forced Overvoltage Condition, $V_{in}=75V$, Min Load, $C_o=none$

Typical Application

Figure 15 shows the recommended connections for the HHS60 Series converter.

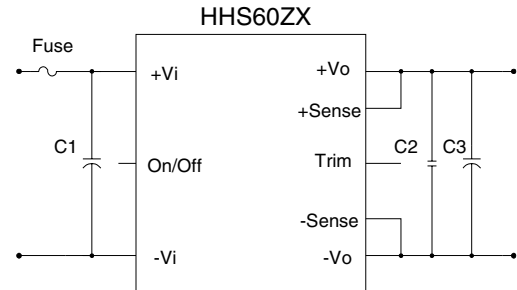

Figure 15. Typical Application of the HHS60 Series

The HHS60 series converters do not require any external components for proper operation. However, if the distribution of the input voltage to the converter contains significant inductance, the capacitor C1 may be required to enhance performance of the converter. A minimum of a 100 μ F electrolytic capacitor with the ESR<0.7 Ω is recommended for the HHS60 series.

If the magnitude of the inrush current needs to be limited, for suggestions see the "Inrush Current Control Application Note" on the Power-One website at www.power-one.com.

For output decoupling we recommend using one 10 μ F tantalum and one 1 μ F ceramic capacitors connected directly across the output pins of the converter. Note, that the capacitors do not substitute the filtering required by the load.

Shutdown Feature Description

The ON/OFF (# 3) pin of the HHS60 Series converters are referenced to the $-V_{in}$ (# 1) pin (see Figure 5). Both negative and positive logic models are available.

With negative logic (which is denoted by the suffix "N" in the part number), when the ON/OFF pin is pulled low, the unit is turned on.

With the positive logic, when the ON/OFF pin is pulled low, the output is turned off and the unit goes into a very low input power mode.

An open collector switch is recommended to control the voltage between the ON/OFF pin and the -Vin pin of the converter. The ON/OFF pin is pulled up internally, so no external voltage source is required.

The user should avoid connecting a resistor between the ON/OFF pin and the +Vin (# 4) pin.

When the ON/OFF pin is used to achieve remote control, the user must take care to insure that the pin reference for the control is actually the -Vin pin. The control signal must not be referenced ahead of EMI filtering, or remotely from the unit. Optically coupling the information and locating the optical coupler directly at the module will solve any of these problems.

Note:

If the ON/OFF pin is not used, it can be left floating (positive logic), or connected to the -Vin pin (negative logic).

Remote Sense

The HHS60 Series converters have the capability to remotely sense both lines of the output. This feature moves the effective output voltage regulation point from the output of the unit to the point of connection of the remote sense pins. This feature automatically adjusts the real output voltage of the converter in order to compensate for voltage drops in distribution and maintain a regulated voltage at the point of load. This is shown in Figures 16 & 17.

If the remote sense feature is not to be used, the sense pins should be connected locally. The +Sense (#8) pin should be connected to the +Vout (#9) pin directly at the output of the converter and the -Sense (#6) pin should be connected to the -Vout (#5) pin directly at the output of the converter.

If sense pins are not connected to load, or the respective output pins, the converter will not be damaged, but may not meet the output voltage regulation specifications.

Output Voltage Trim

The trim feature allows the user to adjust the output voltage from the nominal value. This can be used to compensate for distribution drops, perform margining in production, or accommodate other requirements when output voltage needs to be adjusted from the nominal value. There are two trim options available in the HHS60 Series.

Negative Trim (No P/N suffix)

All HHS60 negative-trim models trim up with a resistor connected from the TRIM (#7) pin to the (-) Sense (#6) pin and trim down with a resistor from the TRIM pin to the (+) Sense (#8) pin as shown in Figure 16.

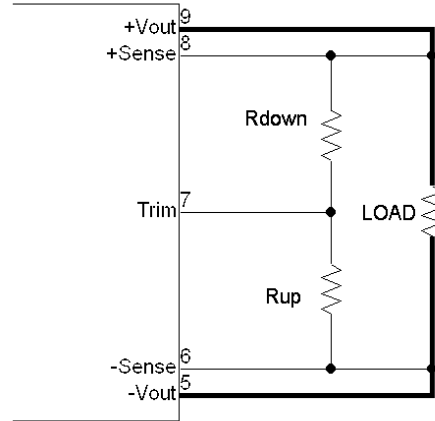

Figure 16. HHS60 Series Negative Trim Schematic

The following equation determines the required external resistor value to obtain an output voltage change of Δ%.

$$R_{\text{trim-dn}} = R1 * \left(\frac{V_o * (100 - \Delta\%) - 122.5}{V_o * \Delta\%} \right) - R2 \text{ K}\Omega$$

$$R_{\text{trim-up}} = \left(\frac{122.5 * R1}{V_o * \Delta\%} - R2 \right) \text{ K}\Omega$$

Where R1 and R2 are constants from the table below

Model	R1 (kΩ)	R2 (kΩ)
HHS60ZA	0.223	0.15
HHS60ZB	0.474	1
HHS60ZD	1.039	3.92
HHS60ZE	4.220	5.11

Optional Positive-Trim (-T, P/N suffix)

The trim feature allows the user to adjust the output voltage from its nominal value.

The HHS60 positive-trim (-T) models trim up with a resistor from the Trim (#7) pin to the +Sense (#8) pin and trims down with a resistor from the Trim pin to the -Sense (#6) pin as shown in the Figure 17.

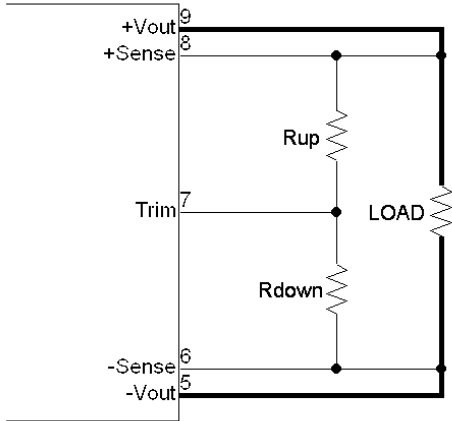

Figure 17. HHS60 Series Positive Trim Schematic

The equations below determine the trim resistor value required to achieve a ΔV change in the output voltage.

$$R_{\text{trim-dn}} = \left(\frac{100}{\Delta\%} - 2 \right) \text{ k}\Omega$$

$$R_{\text{trim-up}} = \left(\frac{V_o \cdot (100 + \Delta\%) \cdot (100 + 2 \cdot \Delta\%)}{1.225 \cdot \Delta\% \cdot \Delta\%} \right) \text{ k}\Omega$$

where ΔV% is the output voltage change expressed in percent of the nominal output voltage, Vout.

Notes:

1. When the output voltage is trimmed up, the output power from the converter must not exceed its maximum rating. The power is determined by measuring the output voltage on the output pins, and multiplying it by the output current.
2. In order to avoid creating apparent load regulation degradation, it is important that the trim resistors are connected directly to the remote sense pins, and not to the load or to traces going to the load.
3. The output voltage increase can be accomplished by either the trim or by the remote sense or by the combination of both. In any case the absolute maximum output voltage

increase shall not exceed the limits defined within the "Features" section above.

4. Either Rup or Rdown should be used to adjust the output voltage according to the equations above. If both Rup and Rdown are used simultaneously, they will form a resistive divider and the equations above will not apply

Safety Considerations

The HHS60 Series converters feature 1500 Volt DC isolation from input to output. The input to output resistance is greater than 10MOhm. These converters are provided with Basic insulation between input and output circuits according to all IEC60950 based standards. Nevertheless, if the system using the converter needs to receive safety agency approval, certain rules must be followed in the design of the system. In particular, all of the creepage and clearance requirements of the end-use safety requirements must be observed. These documents include UL60950 - CSA60950-00 and EN60950, although other or additional requirements may be needed for specific applications.

The HHS60 Series converters have no internal fuse. An external fuse must be provided to protect the system from catastrophic failure, as illustrated in figure 15. Refer to the "Input Fuse Selection for DC/DC converters" application note on www.power-one.com for proper selection of the input fuse. Both input traces and the chassis ground trace (if applicable) must be capable of conducting a current of 1.5 times the value of the fuse without opening. The fuse must not be placed in the grounded input line, if any.

In order for the output of the HHS60 Series converter to be considered as SELV (Safety Extra Low Voltage) or TNV-1, according to all IEC60950 based standards, one of the following requirements must be met in the system design:

- If the voltage source feeding the module is SELV or TNV-2, the output of the converter may be grounded or ungrounded.
- If the voltage source feeding the module is ELV, the output of the converter may be considered SELV only if the output is grounded per the requirements of the standard.
- If the voltage source feeding the module is a Hazardous Voltage Secondary Circuit, the voltage source feeding the module must be provided with at least Basic insulation between the source to the converter and any hazardous

voltages. The entire system, including the HHS60 converter, must pass a dielectric withstand test for Reinforced insulation. Design of this type of systems requires expert engineering and understanding of the overall safety requirements and should be performed by qualified personnel.

Thermal Considerations

The HHS60 Series converters are designed for natural or forced convection cooling. The maximum allowable output current of the converters is determined by meeting the derating criteria for all components used in the converters. For example, the maximum semiconductor junction temperature is not allowed to exceed 120°C to ensure reliable long-term operation of the converters.

The graphs in Figures 5 thru 8 show the maximum output current of the HHS60 Series converters at different ambient temperatures under both natural and forced convection. (longitudinal airflow direction, from pin 1 to pin 4).

Test Setup

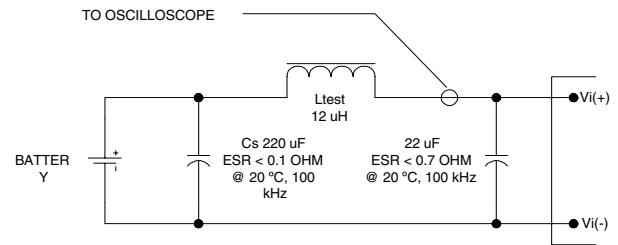
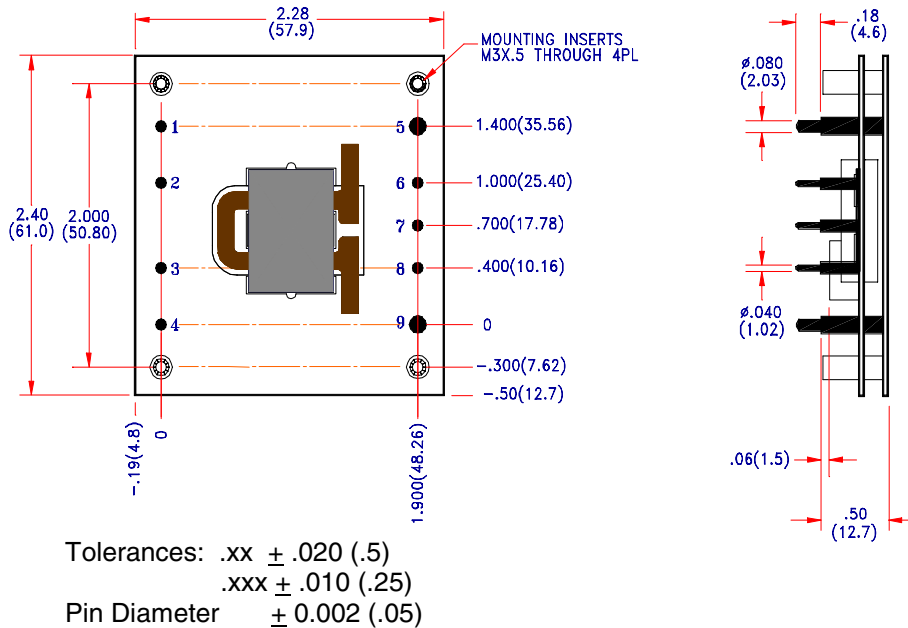

Figure 18. Input Reflected Ripple Current Test Set-up

Note: Measure input reflected-ripple current with a simulated inductance (L_{test}) of 12 μ H. Capacitors offset possible battery impedance. Measure current as shown above

Mechanical Drawing



PIN	FUNCTION
1	-Vin
2	Case Pin
3	On/Off
4	+Vin
5	-Vo
6	-Sense
7	Trim
8	+Sense
9	+Vo

Ordering Information

Options	P/N Suffixes
Trim	Positive (Industry std) - Add "T" suffix
	Negative - no suffix required
Remote ON/OFF	Positive - no suffix required
	Negative - Add "N" suffix
Pin Length	0.18"- Standard - no suffix required
	0.11"- Add "8" suffix ¹
	0.15"- Add "9" suffix ¹

Notes ¹ Consult factory for available options.

NUCLEAR AND MEDICAL APPLICATIONS - Power-One products are not authorized for use as critical components in life support systems, equipment used in hazardous environments, or nuclear control systems without the express written consent of the respective divisional president of Power-One, Inc.

TECHNICAL REVISIONS - The appearance of products, including safety agency certifications pictured on labels, may change depending on the date manufactured. Specifications are subject to change without notice.